

Service Manual

AV Control Stereo Receiver

Receiver



SA-EX300

Colour

(K) Black Type

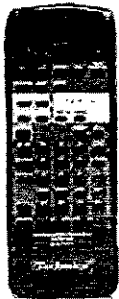

Area

Suffix for Model No.	Area	Colour
(E)	Europe	(K)
(EB)	Great Britain	
(EG)	Germany and Italy	

* Manufactured under license from Dolby Laboratories Licensing Corporation. Additionally licensed under one or more of the following patents: U.S. numbers 3,632,886, 3,746,792 and 3,959,590; Canadian numbers 1,004,603 and 1,037,877.

"Dolby" and the double-D symbol are trademarks of Dolby Laboratories Licensing Corporation.

Specifications

FM Tuner Section

Frequency range	87.50 – 108.00MHz
Sensitivity	
S/N 30dB	1.5µV / 75Ω
S/N 25dB	1.3µV / 75Ω
S/N 20dB	1.2µV / 75Ω
Usable sensitivity	1.5µV / 75Ω
46dB stereo quieting sensitivity	22µV / 75Ω
Total harmonic distortion	
MONO	0.2%
STEREO	0.3%
S/N	
MONO	60dB (75dB, IHF)
STEREO	58dB (71dB, IHF)
Frequency response	20Hz – 15kHz, +1dB, –2dB
Alternate channel selectivity	65dB (±400kHz)
Capture ratio	1dB
Image rejection at 98MHz	40dB
IF rejection at 98MHz	70dB
Spurious response rejection at 98MHz	70dB
AM suppression	50dB
Stereo separation (1kHz)	40dB
Carrier leak	
19kHz	–30dB (–35dB, IHF)
38kHz	–50dB (–55dB, IHF)
Channel balance (250Hz – 6.3kHz)	±1.5dB
Limiting point	1.2µV
Bandwidth	
IF amplifier	180kHz
FM demodulator	1000kHz
Antenna terminal(s)	75Ω (unbalanced)

AM Tuner Section

Frequency range	
AM (.. EG) / MW (.. E,EB)	522 – 1611kHz (9kHz steps)
LW (.. E,EB)	530 – 1620kHz (10kHz steps) 144 – 288kHz
Sensitivity	
AM (.. EG) / MW (.. E,EB)	20µV, 330µV/m
LW (.. E,EB)	45µV

Selectivity

AM (.. EG) / MW (.. E,EB)	55dB (at 999kHz)
LW (.. E,EB)	55dB (at 252kHz)
Image rejection	
AM (.. EG) / MW (.. E,EB)	40dB (at 999kHz)
LW (.. E,EB)	40dB (at 252kHz)
IF rejection at 1000 kHz	
AM (.. EG) / MW (.. E,EB)	55dB (at 999kHz)
LW (.. E,EB)	55dB (at 252kHz)

Video Section

Output voltage at 1 V input (unbalanced)	1 ± 0.1Vp-p
Maximum input voltage	1.5Vp-p
Input/Output impedance	75Ω (unbalanced)

Amplifier Section

Power output (at 240V)	
DIN 1kHz (T.H.D. 1%)	2 X 50W (4Ω)
40Hz – 20kHz continuous power output both channels driven	2 X 30W (8Ω)
Total harmonic distortion	
Rated power at 40Hz – 20kHz	0.5% (8 Ω)
Half power at 1kHz	0.03% (8 Ω)
Power output at the Dolby Pro Logic operation	
DIN 1kHz (T.H.D. 1%)	
Front	2 x 40 W (8Ω)
Center	40 W (8Ω)
Surround	40 W (8Ω)
Intermodulation distortion	
rated power at 60Hz : 7kHz 4:1, SMPTE	0.5% (8Ω)
Power bandwidth	
both channels driven, 3dB	10Hz 40kHz (8Ω)
Damping factor	30 (8Ω)
Load impedance	
Front	4 – 6Ω
Center	8 – 16Ω
Surround	4 – 16Ω
Frequency response	
PHONO	RIAA standard curve ±0.8dB
CD, VCR 1, TV/VCR 2, TAPE	10Hz – 40kHz, ±3dB

Technics®

© 1996 Matsushita Electronics (S) Pte. Ltd.
All rights reserved. Unauthorized copying and distribution is a violation of law.

⚠ WARNING

This service information is designed for experienced repair technicians only and is not designed for use by the general public. It does not contain warnings or cautions to advise non-technical individuals of potential dangers in attempting to service a product. Products powered by electricity should be serviced or repaired only by experienced professional technicians. Any attempt to service or repair the product or products dealt with in this service information by anyone else could result in serious injury or death.

Input sensitivity and Impedance

PHONO	3mV / 47kΩ
CD, VCR 1, TV/VCR 2, TAPE	200mV / 22kΩ
S/N at rated power (8Ω)	
PHONO	70dB (IHF, A: 80dB)
CD, VCR 1, TV/VCR 2, TAPE	75dB (IHF, A: 88dB)
Tone controls	
BASS	50Hz, ±10dB
TREBLE	20kHz, ±10dB
Output voltage	
VCR 1, OUT, TAPE REC (OUT)	200mV
Channel balance (250Hz – 6.3kHz)	±1dB
Channel separation	55dB
Headphones output level and impedance	430mV / 330Ω

■ General

Power consumption	220W
Power supply	
For E, EB	AC 50 Hz, 230 – 240V
For EG	AC 50 Hz, 230V
Dimensions (W x H x D)	430 X 136 X 358mm
Weight	8.7kg

Notes :

- Specifications are subject to change without notice. Weight and dimensions are approximate.
- Total harmonic distortion is measured by the digital spectrum analyzer.



■ Contents

	Page		Page
CAUTION FOR AC MAINS LEAD	2	BLOCK DIAGRAM	26 ~ 29
BEFORE REPAIR AND ADJUSTMENT	3	WIRING CONNECTION DIAGRAM	30
PROTECTION CIRCUITRY	3	PRINTED CIRCUIT BOARD	31 ~ 36
TERMINAL GUIDE OF ICs, TRANSISTORS AND DIODES	3	CABINET PARTS LOCATION	37
OPERATION CHECKS & MAIN COMPONENT REPLACEMENT	4 ~ 7	REPLACEMENT PARTS LIST	38 ~ 40
TROUBLESHOOTING	8 ~ 11	PACKAGING	40
TERMINAL FUNCTION OF ICs	11	RESISTORS & CAPACITORS	41 ~ 44
SCHEMATIC DIAGRAM	12 ~ 25		

■ Caution for AC Mains Lead**[For [EB] area.]**

For your safety, please read the following text carefully.

This appliance is supplied with a moulded three pin mains plug for your safety and convenience. A 5-ampere fuse is fitted in this plug. Should the fuse need to be replaced please ensure that the replacement fuse has a rating of 5-ampere and that it is approved

by ASTA or BSI to BS1362. Check for the ASTA mark  or the BSI mark  on the body of the fuse.

CAUTION !

IF THE FITTED MOULDED PLUG IS UNSUITABLE FOR THE SOCKET OUTLET IN YOUR HOME THEN THE FUSE SHOULD BE REMOVED AND THE PLUG CUT OFF AND DISPOSED OFF SAFELY. THERE IS A DANGER OF SEVERE ELECTRICAL SHOCK IF THE CUT OFF PLUG IS INSERTED INTO ANY 13-AMPERE SOCKET.

If the plug contains a removable fuse cover you must ensure that it is refitted when the fuse is replaced.

If you lose the fuse cover, the plug must not be used until a replacement cover is obtained. A replacement fuse cover can be purchased from your local dealer.

If a new plug is to be fitted, please observe the wiring code as shown below.

If in any doubt please consult a qualified electrician.

IMPORTANT

The wires in this lead are coloured in accordance with the following code:

Blue: Neutral
Brown: Live

As the colours of the wires in the mains lead of this appliance may

not correspond with the coloured markings identifying the terminals in your plug, proceed as follows:

The wire which is coloured BLUE must be connected to the terminal in the plug which is marked with the letter N or coloured BLACK. The wire which is coloured BROWN must be connected to the terminal in the plug which is marked with the letter L or coloured RED.

Under no circumstances should either of these wires be connected to the earth terminal of the three pin plug, marked with the letter E or the Earth symbol .

Before use

Remove the connector cover as follows.

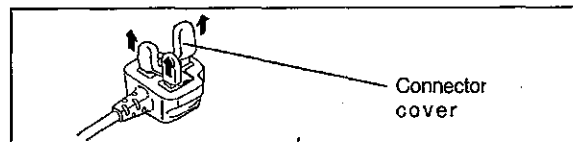
**How to replace the fuse**

1. Remove the fuse cover with a screwdriver.

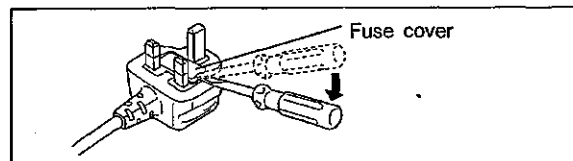

2. Replace the fuse and attach the fuse cover.

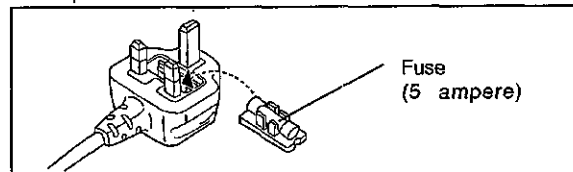

Before Repair and Adjustment

Disconnect AC power, discharge both Power Supply Capacitors (C703 and C704) through a 10Ω, 5W resistor to ground. DO NOT SHORT-CIRCUIT DIRECTLY (with a screwdriver blade, for instance), as this may destroy solid state devices. After repairs are completed, restore power gradually using a variac, to avoid overcurrent.
For E,EB : Current consumption at 240V, 50 Hz in NO SIGNAL mode should be 120 ~ 350 mA.
For EG : Current consumption at 230V, 50 Hz in NO SIGNAL mode should be 130 ~ 380 mA.

Protection Circuitry

The protection circuitry may have operated if either of the following conditions are noticed:

- No sound is heard when the power is turned on.
- Sound stops during a performance.

The function of this circuitry is to prevent circuitry damage if, for example, the positive and negative speaker connection wires are "shorted", or if speakersystems with an impedance less than the indicated rated impedance of the amplifier are used.





If this occurs, follow the procedure outlines below:

1. Turn off the power.
2. Determine the cause of the problem and correct it.
3. Turn on the power once again after one minute.

Note:

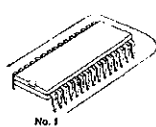
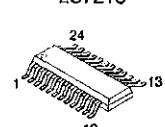
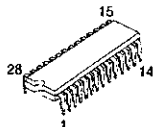
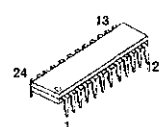
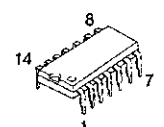
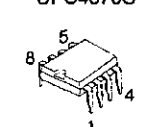
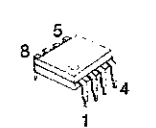
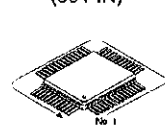
When the protection circuitry functions, the unit will not operate unless the power is first turned off and then on again.

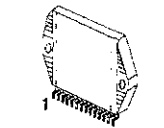
Terminal Guide of ICs, Transistors and Diodes

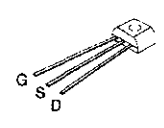
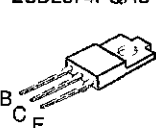
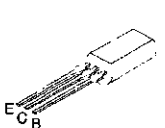
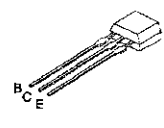
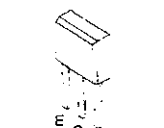
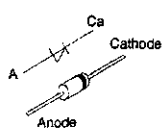
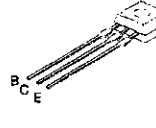
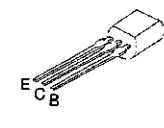
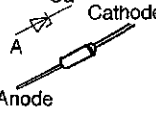
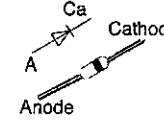
<p>LA2785 (42 PIN)</p> 	<p>LA1832A LC7218</p> 	<p>TC9163N</p> 	<p>LV1010N</p> 	<p>NJM2279D</p> 	<p>AN6558-F UPC4570C</p> 
<p>M5218AP</p> 	<p>UPD78043D047 (80 PIN)</p> 	<p>BA6218</p> 	<p>RSN3403-P</p> 	<p>STK311-010</p> 	<p>2SK544F-AC</p> 
<p>2SB1548PQAU 2SD2374PQAU</p> 	<p>2SC3940AQSTA</p> 	<p>2SA933SSTA RVTDC114YST</p> 	<p>2SC3311ARTA</p> 	<p>1N5402BM21</p> 	
	<p>2SC2787LTA 2SD1915FTA UN411FTA UN421FTA</p>	<p>2SA1309ARTA 2SC2785FETA 2SC2786MTA 2SC2787FL1TA</p>		<p>2SB621ARTA 2SC2631QRSTA 2SD592AQRSTA</p>	
	<p>MTZJ10CTA MTZJ15CTA MTZJ27DTA MTZJ3R9ATA MTZJ4R7BTA MTZJ5R1BTA</p>	<p>MTZJ5R8BTA MTZJ6R2BTA MTZJ6R8BTA MTZJ7R5CTA MTZJ24DTA</p>		<p>1SR35200TB 1SS291TA RVD1SS133TA MA165TA</p>	



■ Operation Checks and Main Component Replacement Procedures

"ATTENTION SERVICER" Some chassis components may have sharp edges.
Be careful when disassembling and servicing.

1. This section describes procedures for checking the operation of the major printed circuit boards and replacing the main components.
2. For reassembly after operation checks or replacement, reverse the respective procedures. Special reassembly procedures are described only when required.
3. Select items from the following index when checks or replacement are required.

• Contents	page
• Checking Procedure for Major P.C.B.	4 ~ 5
• Main Component Replacement Procedures	6 ~ 7

■ Checking Procedure for Major P.C.B.

	a [SNE2129-1] (Black)
	b, c [XTBS3+8JFZ1] (Black)

Step 1
a X 4

Step 2
b X 2

Step 3 Remove the top cabinet.

Panel P.C.B. (Solder side)
IN/OUT terminal P.C.B. (Component side)
Tuner P.C.B. (Solder side)

• Check the Panel P.C.B., Tuner P.C.B. and IN/OUT terminal P.C.B. as shown above.

Step 4
c X 3

Step 5
Release the two front claws and pull out the front panel assembly. Take note of the connectors as you remove the front panel assembly. (CN901 to CN905)

Step 6
Remove the connection from CN771.

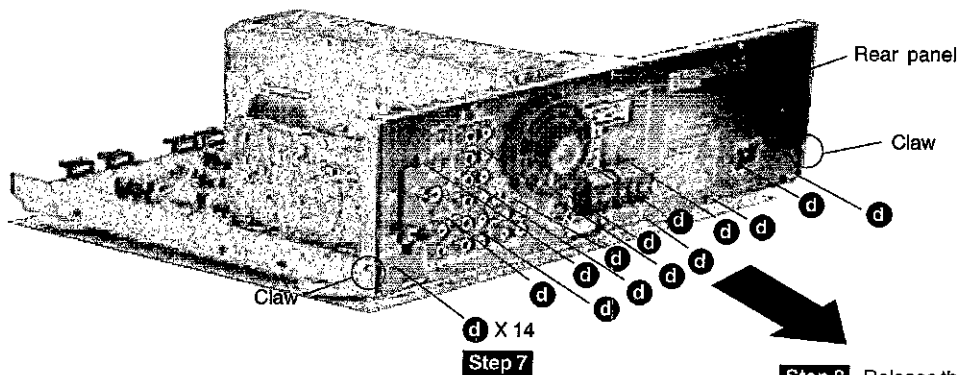

Step 7

Step 8

Release the claws and then remove the rear panel.

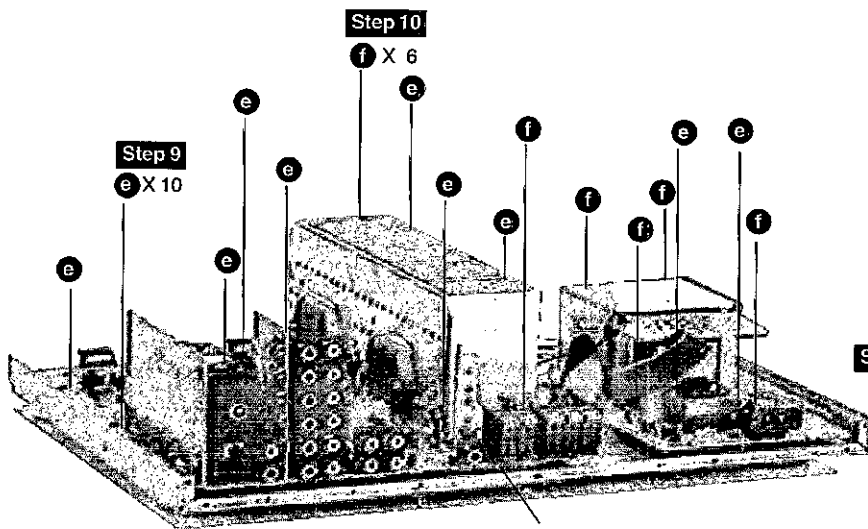

Step 10

Step 9

Step 11

Remove the Main P.C.B.

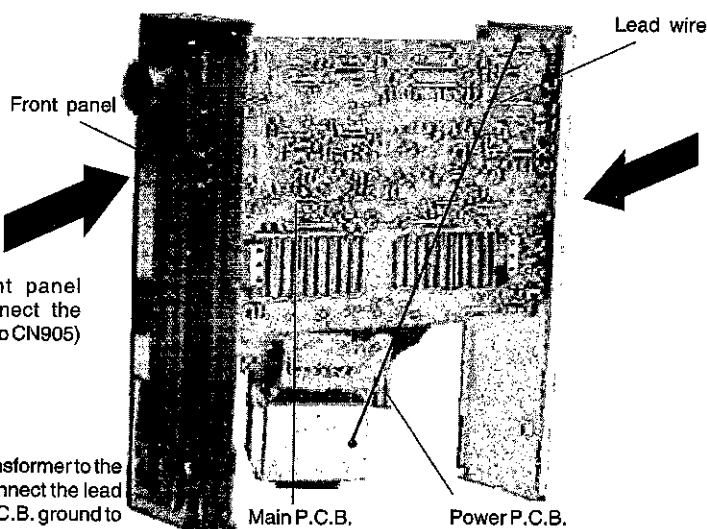

Step 15

Check the Main P.C.B. and the Power P.C.B. as shown on the left.

Step 12

Install the rear panel temporarily on the Main P.C.B. again.

Step 13

Fix back the front panel assembly and connect the connectors. (CN901 to CN905)

Step 14

Connect back the transformer to the power P.C.B. and connect the lead wire from the main P.C.B. ground to the transformer ground plate. Connect back the connection for CN771.

	d [XTBS3+8JFZ1] (Black)
	e [XTB3+20JFZ] (Black)
	f [XTB3+8FFZ] (Black)

■ Main Component Replacement Procedures

1. Replacement of the Power IC and Regulator Transistor

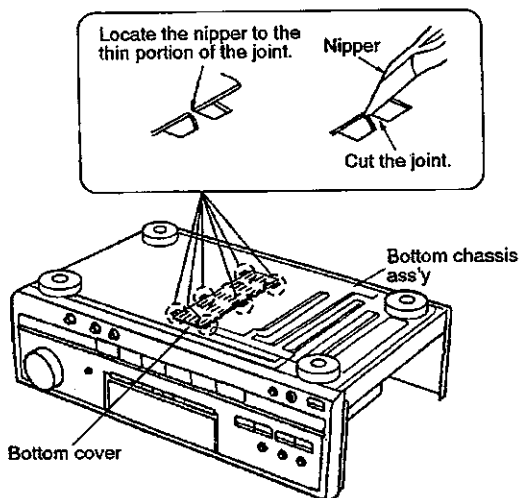

1. Cut the joints(6 portions) between bottom cover and bottom chassis ass'y with nipper.

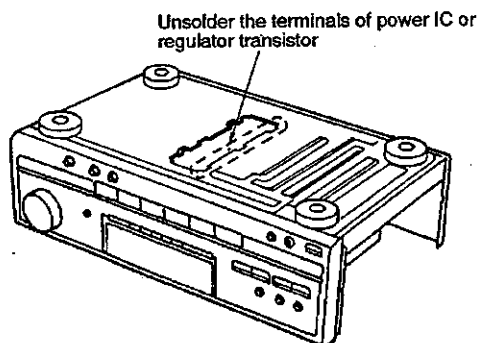

3. When replacing the power IC or regulator transistor, unsolder the terminals of power IC or regulator transistor on the soldered surface.

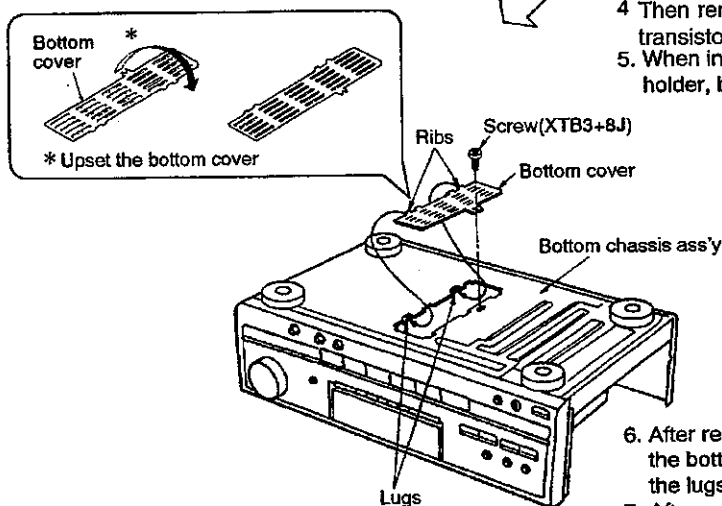

6. After replacing the power IC or regulator transistor, upset the bottom cover and align the ribs of the bottom cover to the lugs on the bottom chassis ass'y.
7. After mounting the bottom cover on the bottom chassis ass'y, fix it with a screw(XTB3+8J).

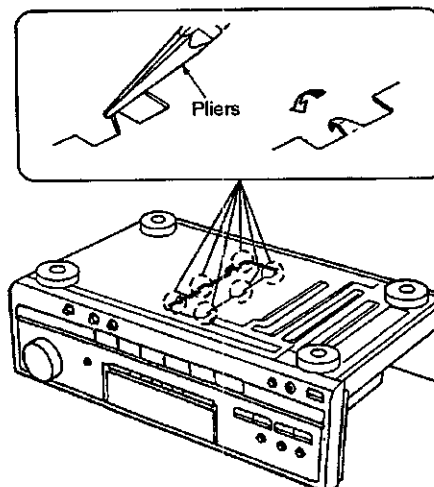

2. After cutting the joints(6 portions), bend the portions of the bottom chassis ass'y in the direction of arrow with pliers.

CAUTION

- After replacing the power IC or regulator transistor, apply a sufficient quantity of compound grease (RFKX0002) between the heat sink and the power IC or regulator transistor. (Radiation of power IC & transistor)
- Tighten enough the screws after replacing the power IC or regulator transistor. Otherwise, the heat radiation works little.

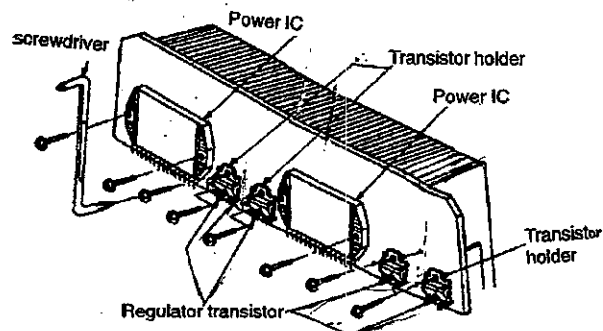

4. Then remove the screws fixed to the power IC or transistor holder.
5. When installing or removing the power IC or transistor holder, be sure to use an offset screwdriver.

CAUTION:

1. A long straight screwdriver cannot be used for removal or mounting since its long grip interferes with the neighboring P.C.B. (See Fig.1)
2. A short straight screwdriver may be used for removal, but cannot be used for mounting because the limited space in the unit will not allow sufficient tightening torque. (See Fig.2)

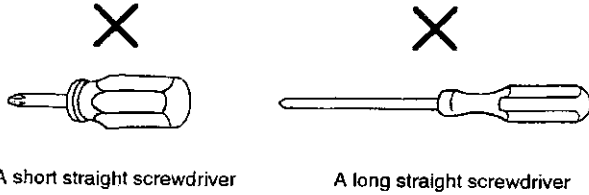

A short straight screwdriver
Fig.2

A long straight screwdriver

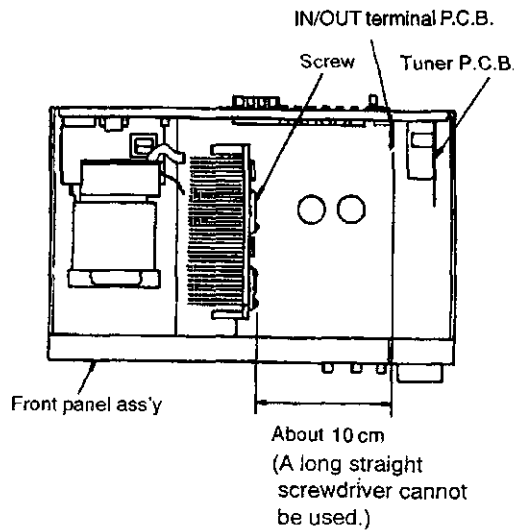
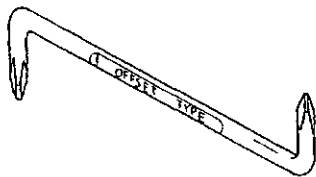

Fig.1

3. Insufficient tightening will cause poor heat dissipation from the power IC and regulator transistor and, in the worst case, may lead their thermal breakdown. (See Fig.2)

—OFFSET SCREWDRIVER—

- The PROTO offset screwdriver No.34- 1/4 is recommended for use in the application above.



No.		
34 1/4	1 & 2	4 3/4"

2. Replacement of the fan motor

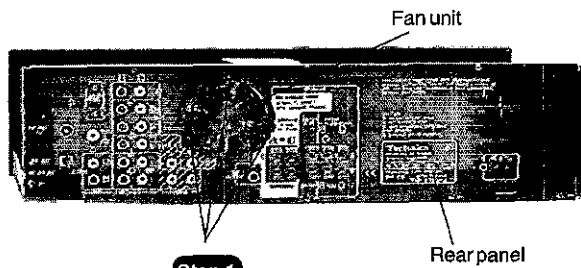

Step 1
Release the 3 claws.

NOTE

When replacing the fan motor, align the boss of the fan case with the hole of the fan motor.

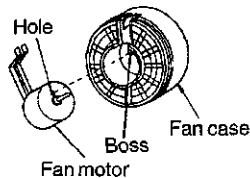

Step 2
Put a screwdriver at the root of the fan and remove it.

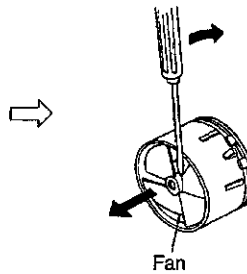

Step 3
Remove the fan cap.

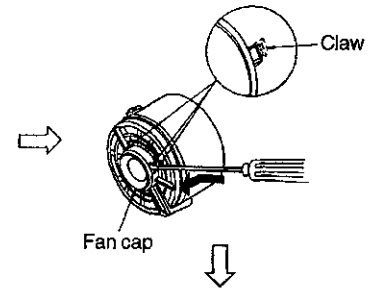

Step 4
Desolder the wires from the motor terminal and replace it with a new one.

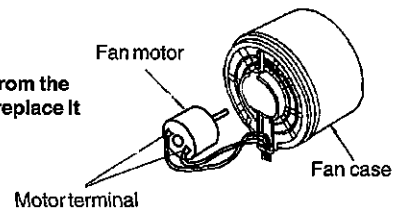

Troubleshooting

This unit has test points on each circuit board block for use in troubleshooting.

CONNECTION

Connect either a CD player, tape deck or AF oscillator to the input terminals of the unit.

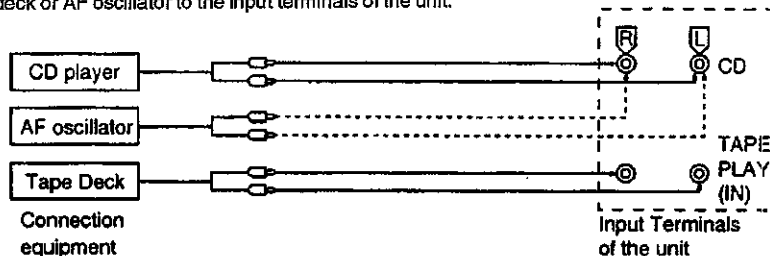

REQUIRED ITEMS

- Testing with a CD player ——— Test deck (SZZP1054C / first program, 1kHz, 0dB)
- Testing with a tape deck ——— Test tape (QZZCLA / 315Hz, 0dB)
- Testing with a AF oscillator ——— Set the output at 500Hz, 200mV
- Oscilloscope (min. 10MHz) - - - - - To measure the output waveform at the test points.

TEST PROCEDURE FOR AMPLIFIER CIRCUIT

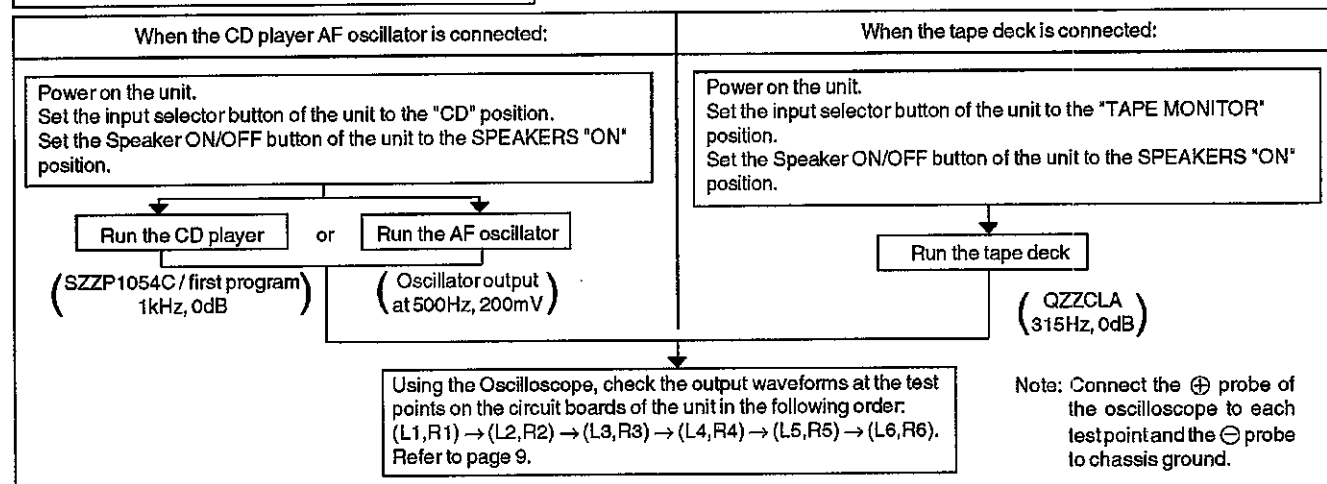





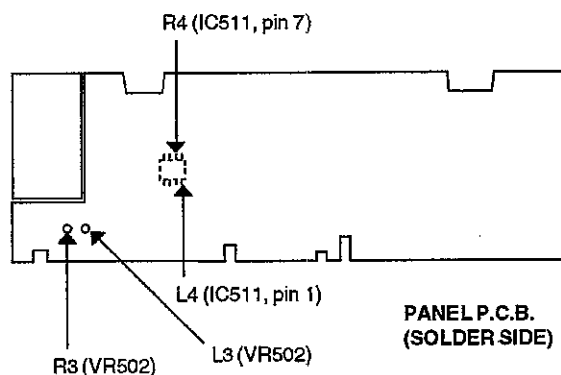
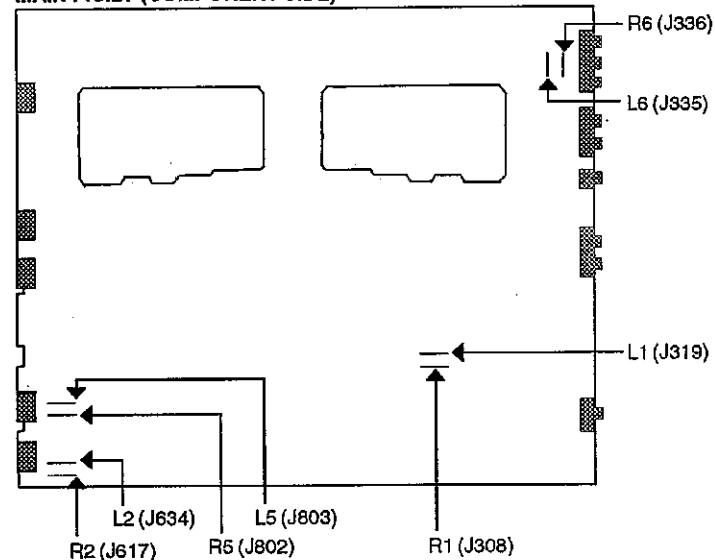



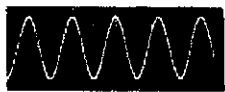
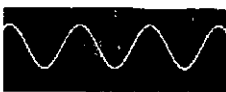
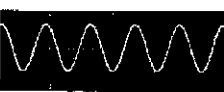
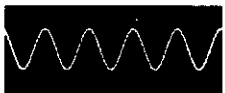
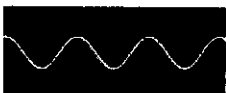
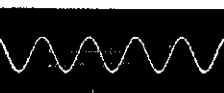
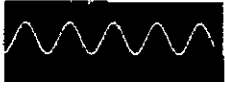

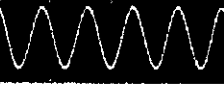
TEST POINTS POSITIONS OF AMPLIFIER CIRCUIT

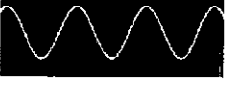
MAIN P.C.B. (COMPONENT SIDE)

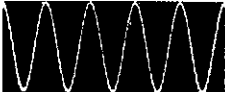
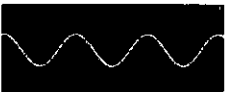
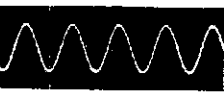

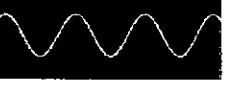
NORMAL WAVEFORMS OF AMPLIFIER CIRCUIT AND LIKELY FAULTY BLOCKS

TP	CD player	Tape deck	AF oscillator	Likely faulty block if the normal waveform shown at the left is not present.
L1/R1	 0.5 msec 2V	 1 msec 500 mV	 1 msec 500 mV	Input selector block IC402 & area
L2/R2	 0.5 msec 200 mV	 1 msec 500 mV	 1 msec 500 mV	Dolby pro logic block IC1001, IC1002 & area
L3/R3	 0.5 msec 50 mV	 1 msec 100 mV	 1 msec 50 mV	Master volume block VR501 & area
L4/R4	 0.5 msec 500 mV	 1 msec 500 mV	 1 msec 1V	Tone control block IC511 & area
L5/R5	 0.5 msec 100 mV*	 1 msec 500 mV	 1 msec 500 mV	Power limiter block Q505 and Q506 & area
L6/R6	 0.5 msec 5V	 1 msec 500 mV*	 1 msec 1V*	Main amplifier block IC601 & area

Measurement conditions. Volume control (VR501), Treble control (VR512) and Bass control (VR511) positions : 0

*Volume control position (VR501) for these test

: 0

CHECKING PROCEDURE FOR SURROUND CIRCUIT

Outputting surround signals normally requires that opposite phase signals be applied to both the left and right channels. However, this unit incorporates a service mode, allowing the surround circuit to be tested using in-phase signals.

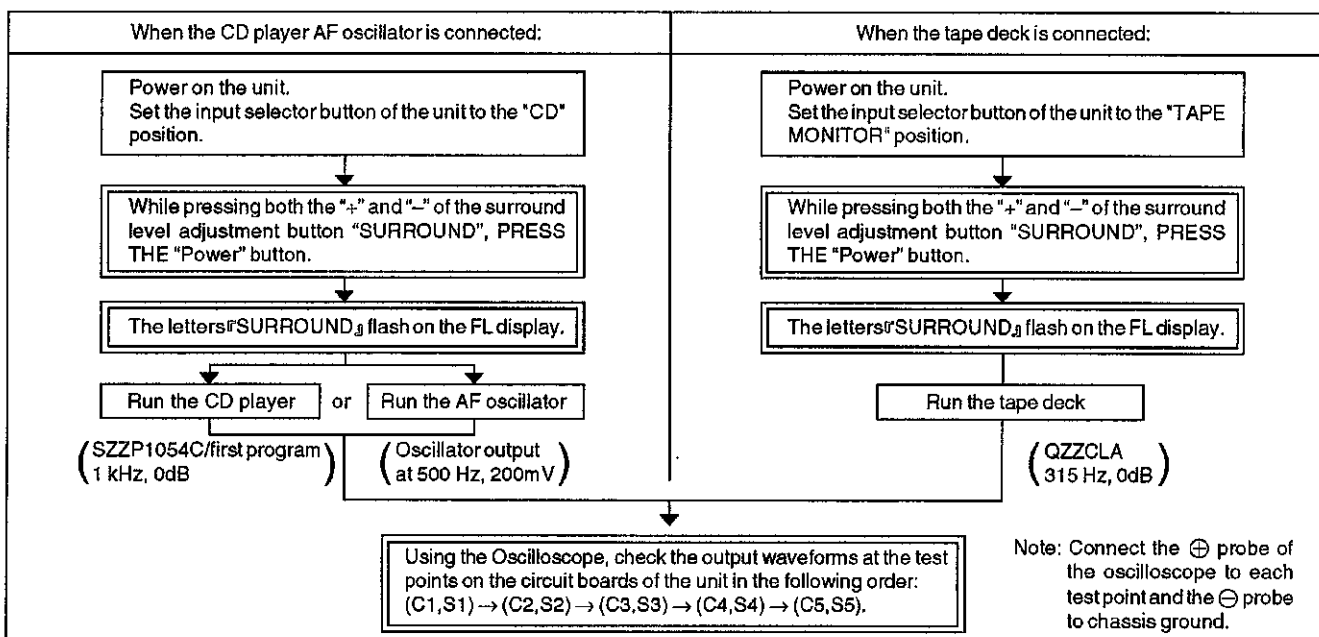

• To Exit the service mode, power off the unit.

TEST POINTS POSITIONS OF SURROUND CIRCUIT

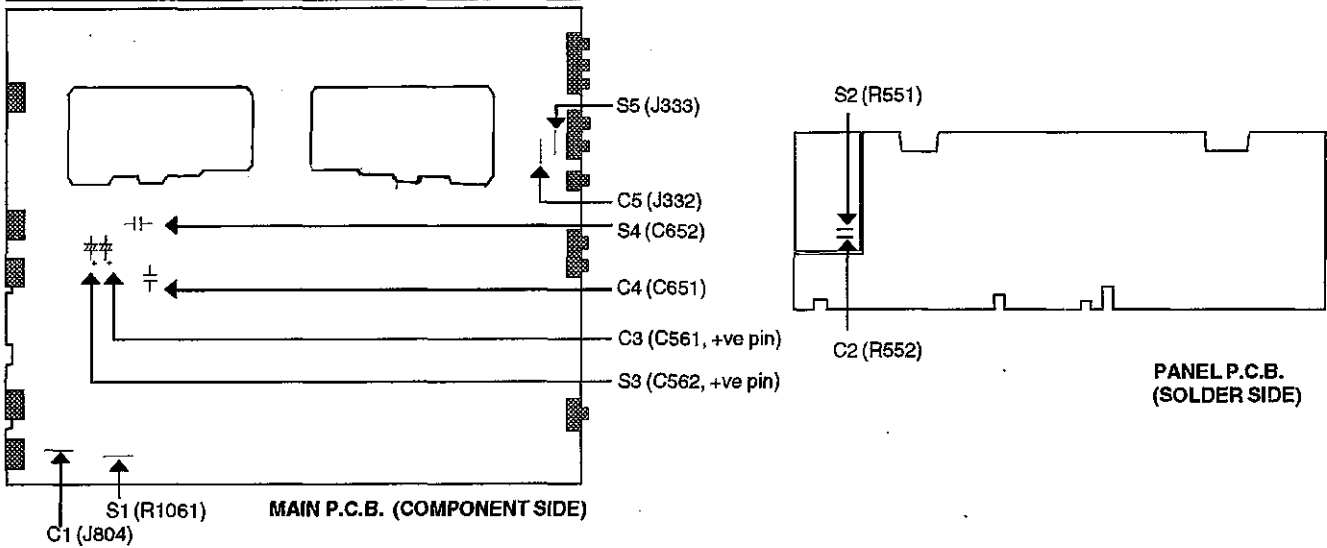

NORMAL WAVEFORMS OF SURROUND CIRCUIT AND LIKELY FAULTY BLOCKS

TP	CD player	Tape deck	AF oscillator	Likely faulty block if the normal waveform shown at the left is not present.
C1/S1	 0.5 msec 500 mV	 1 msec 200 mV	 1 msec 200 mV	Dolby pro logic block IC1001, IC1002 & area
C2/S2	 0.5 msec 100 mV	 1 msec 20 mV	 1 msec 20 mV	Master volume block VR501 & area
C3/S3	 0.5 msec 2 V	 1 msec 500 mV	 1 msec 500 mV	Tone control block IC551 & area
C4/S4	 0.5 msec 200 mV*	 1 msec 500 mV	 1 msec 500 mV	Power limiter block through Q551, Q552 & area
C5/S5	 0.5 msec 100 mV*	 1 msec 10 V	 1 msec 20 V	Main amplifier block IC602 & area

Measurement conditions. Volume control (VR501), Treble control (VR512) and Bass control (VR511) positions : ○
 *Volume control position (VR501) for these test : ○

CIRCUIT BLOCKS

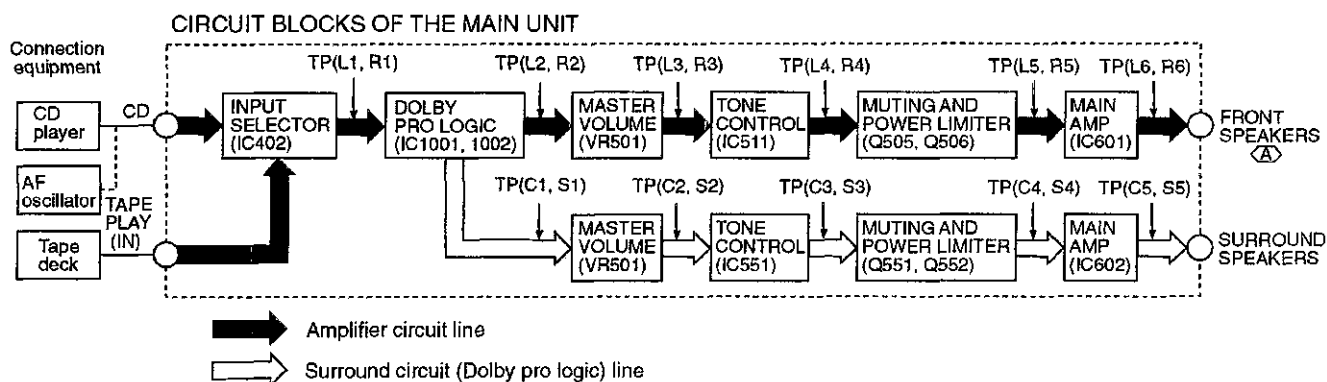

OVERLOAD DETECTION FUNCTION

The HIC protection circuit functions if any cord at a speaker terminal is short-circuited or if the unit overheats because of improper operation. At the same time, **OVERLOAD** scrolls across the FL display.

In this state, all keys remain inoperative; if any key is pressed, **SWITCH OFF POWER** scrolls across the FL display.

If an overload occurs, immediately power off the unit and check the speaker connections and venting holes. After fixing any faults, power on the unit again and check for proper operation.

If no detects are found, or if the unit remains overloaded after it is power on again, check the circuit for faults.

Terminal Function of ICs

• IC901 (UPD78043D047) System Microprocessor

Pin No.	Mark	I/O	Function
1-7	D4-D10	O	Digit signal of FL display
8	VDD	I	Power supply terminal
9	SUR/OSD_CK	-	Not used
10	SUR/OSD_DT	-	Not used
11	VIDEO_DET	I	RDS detect terminal
12	SUR_CE	-	Not used
13	VOL_UP	O	Rotate control terminal of
14	VOL_DWN	O	volume motor
15	LOUDNESS	-	Not used
16	FM_STEREO	I	Stereo signal detect terminal
17	RESET	I	Reset detect terminal
18	SD	I	Received signal detect terminal
19	OSD_ST	-	Not used
20	GND	-	GND terminal
21	VIDEO_B	-	Not used
22	VIDEO_A	-	Not used
23	IF_DATA	I	Serial data signal
24	THERMAL	-	Not used
25-28	KEY1-KEY4	I	Key matrix detect terminal
29	AVDD	I	Power supply terminal
30	AVREF	I	Power supply terminal
31	OVERLOAD	I	Over load detect terminal
32	XT2	-	Not used
33	GND	-	GND terminal
34	XIN	I	Crystal oscillator terminal
35	XOUT	O	(4MHz)

Pin No.	Mark	I/O	Function
36-39	SFC1-SFC4	-	Not used
40	RDS_DT	I	RDS data signal
41	TNR_CE	O	Chip enable signal
42	SEL/TNR_DT	O	Serial data signal
43	SEL/TNR_CK	O	Serial clock signal
44	RDS_ST	O	RDS start signal
45	RDS_CLK	O	RDS clock signal
46	HOLD	I	Hold signal input terminal
47	REMOTE	I	Remote control terminal
48	GND	-	Not used
49	SEL_ST	O	Level shift control terminal
50	HELP_LED	-	Not used
51	STANDBY_LED	-	Not used
52	VDD	I	Power supply terminal
53	REC_MUTE	-	Not used
54	S/C_SP	-	Not used
55	SP_B	-	Not used
56	SP_A	O	Speaker select control terminal
57	POWER_RLY	O	Relay control terminal
58	AF_MUTE	O	Muting control terminal
59	LIMITER	-	Not used
60	INIT_IN	-	Not used, connect to resistor
61-70	S16-S7	O	Segment signal of FL display
71	VLOAD	I	Power supply terminal
72-77	S6-S1	O	Segment signal of FL display
78-80	D1-D3	O	Digit signal of FL display

■ Schematic Diagram

(All schematic diagrams may be modified at any time with the development of new technology)

Note :





< for Main circuit and In/Out Terminal circuit > (Page 13 ~ 17)

< for Tuner circuit > (Page 18 ~ 21)

< for Panel circuit, Power Supply circuit, Headphone Jack circuit, Operation circuit, Transformer circuit and Volume circuit > (Page 22 ~ 25)

• S946	:	Powerswitch
• S947	:	Phono select switch
• S948	:	Muting switch
• S950	:	FM Auto / Mono switch
• S951	:	Band select switch
• S952	:	Tuning decrease switch
• S953	:	Tuning increase switch
• S954	:	Memory manual/auto switch
• S956	:	Preset decrease switch
• S957	:	Preset increase switch
• S960	:	Tuner select switch
• S961	:	CD select switch
• S962	:	Tape select switch
• S963	:	TV / VCR2 select switch
• S964	:	VCR1 select switch
• S970	:	Search select switch
• S971	:	Enhanced other network select switch
• S972	:	Program type increase switch
• S973	:	Program type decrease switch
• S974	:	Display mode select switch
• S980	:	Speakers on/off switch
• S983	:	Surround select switch
• S974	:	3 Stereo select switch
• S980	:	Center mode select switch
• VR501-1 ~ VR501-4	:	Volume control
• VR502	:	Balance control
• VR511-1 ~ VR511-2	:	Bass control
• VR512-1 ~ VR512-2	:	Treble control

• Signal line

	:	+B line		:	AM signal line
	:	Main signal line		:	AM OSC signal line
	:	FM signal line		:	FM OSC signal line

•The voltage value and waveforms are the reference voltage of this unit measured by DC electronic voltmeter (high impedance) and oscilloscope on the basis of chassis.

Accordingly, there may arise some error in voltage values and waveforms depending upon the internal impedance of the tester or the measuring unit.

() AM

< > FM

•Importance safety notice:

Components identified by  mark have special characteristics important for safety. Furthermore, special parts which have purposes of fire-retardant (resistors), high-quality sound (capacitors), low-noise (resistors), etc. are used. When replacing any of components, be sure to use only manufacturer's specified parts shown in the parts list.

Caution !

IC, LSI and VLSI are sensitive to static electricity.

Secondary trouble can be prevented by taking care during repair.

- Cover the parts boxes made of plastics with aluminium foil.
- Ground the soldering iron.
- Do not touch the pins of IC, LSI or VLSI with fingers directly.
- Put a conductive mat on the work table.

E MAIN CIRCUIT

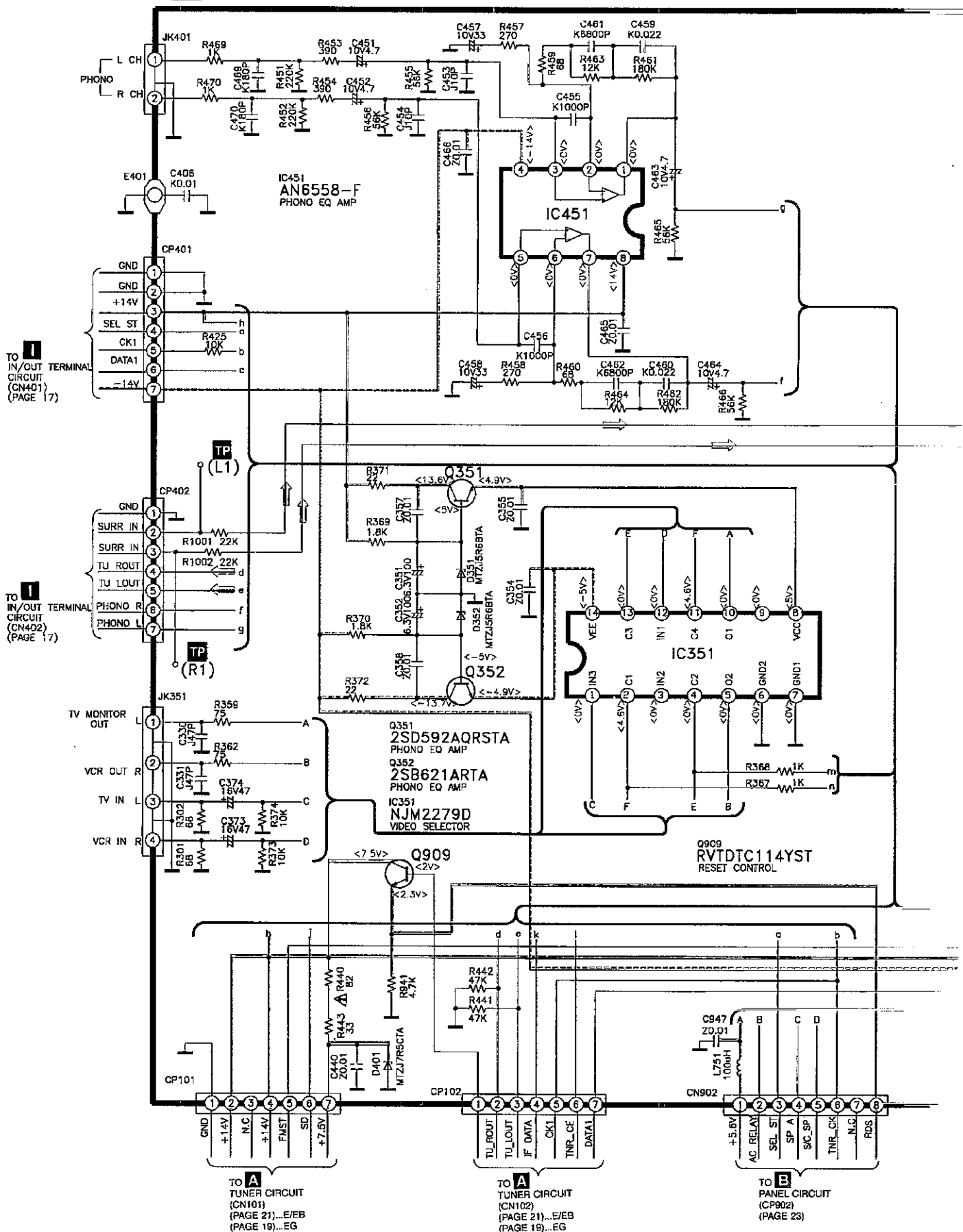

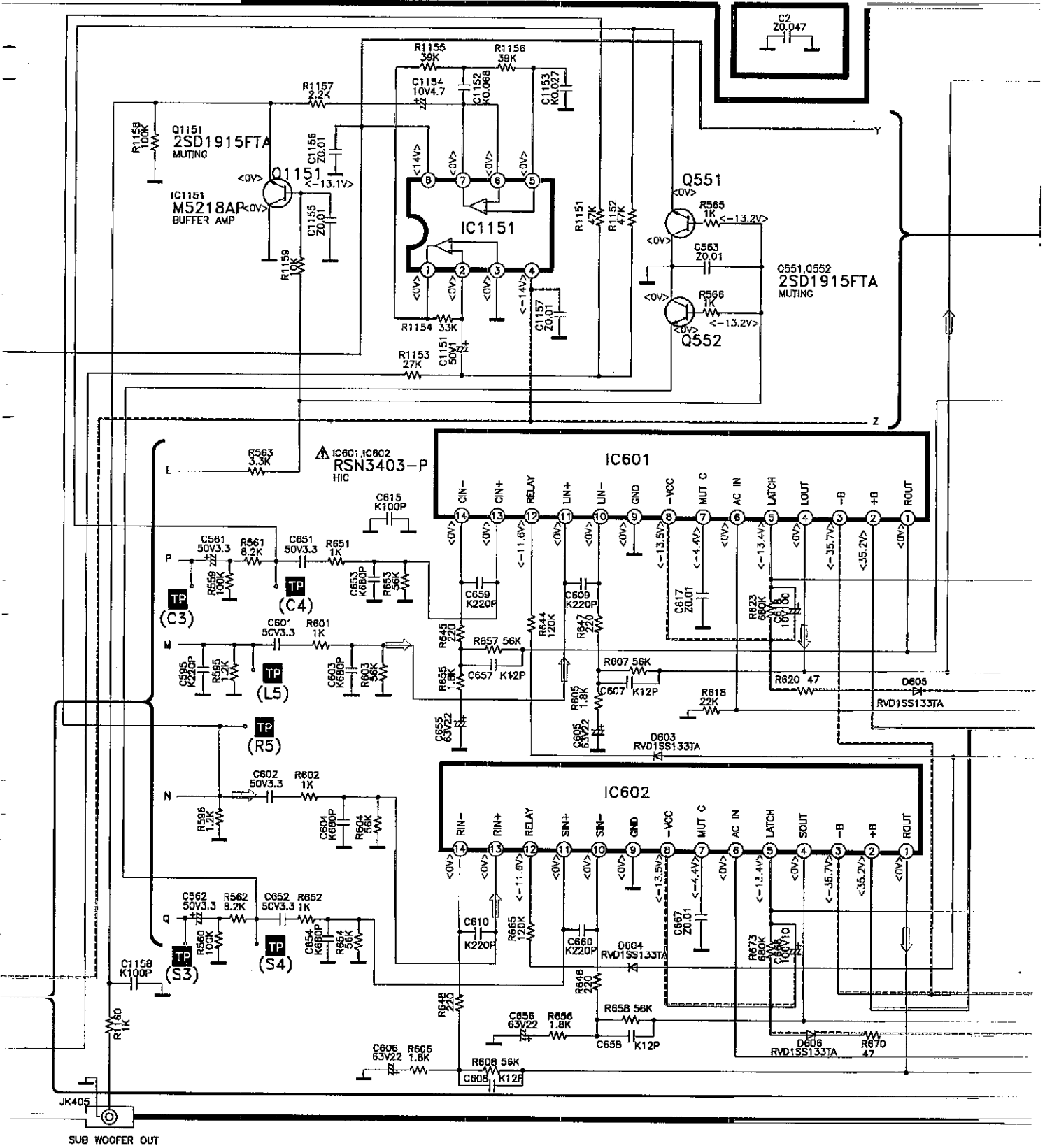

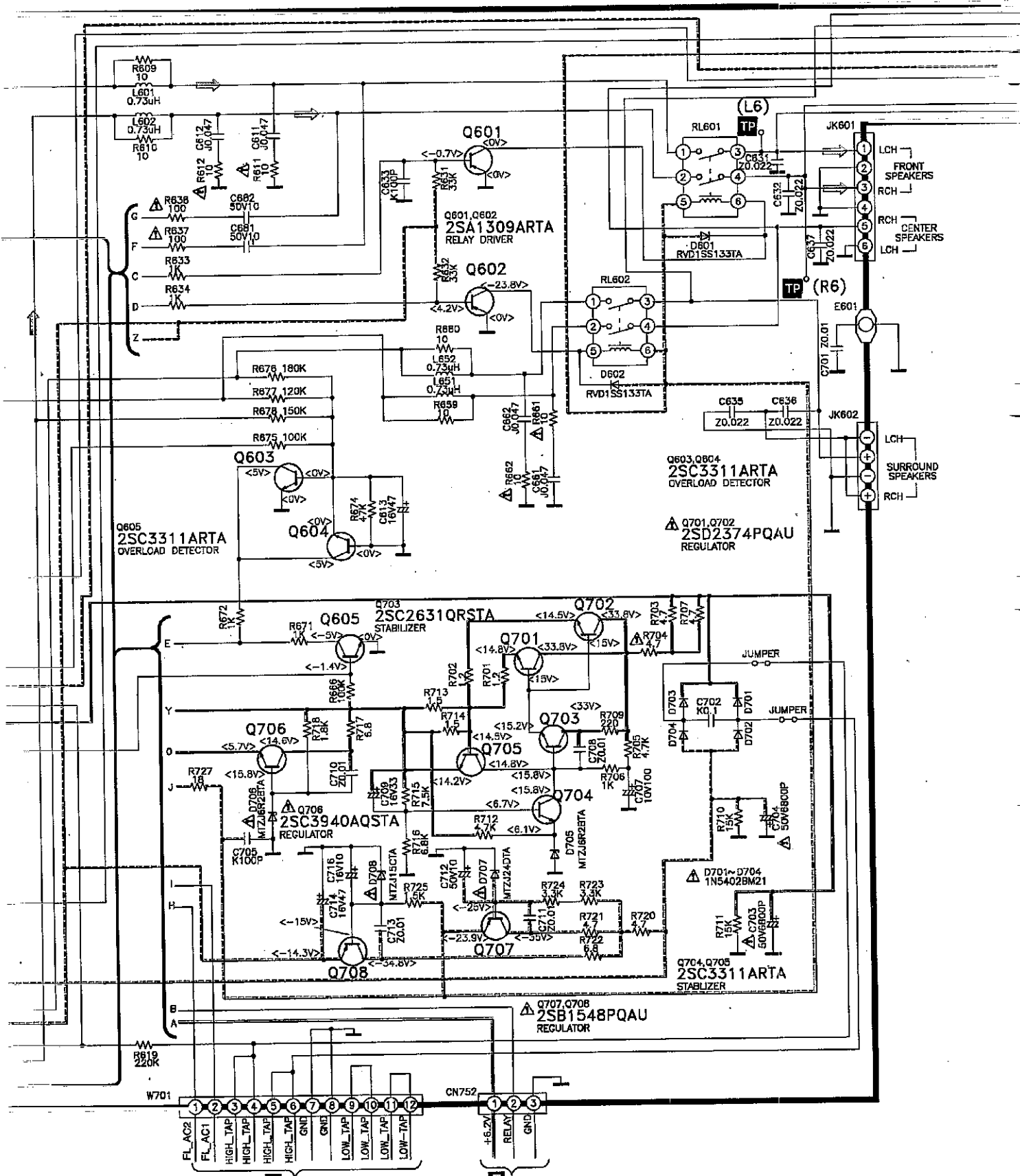

Q605
2SC3311ARTA
OVERLOAD DETECTOR

Q601, Q602
2SA1309ARTA
RELAY DRIVER

Q603, Q604
2SC3311ARTA
OVERLOAD DETECTOR

Q701, Q702
2SD2374PQAU
REGULATOR

Q703
2SC2631QRSTA
STABILIZER

Q706
2SC3940AQ5TA
REGULATOR

Q704, Q705
2SC3311ARTA
STABILIZER

Q707, Q708
2SB1548PQAU
REGULATOR

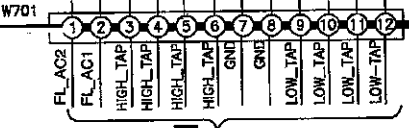

TO **G**
TRANSFORMER CIRCUIT
(W701)
(PAGE 22)

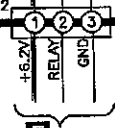

TO **F**
POWER SUPPLY CIRCUIT
(W752)
(PAGE 22)

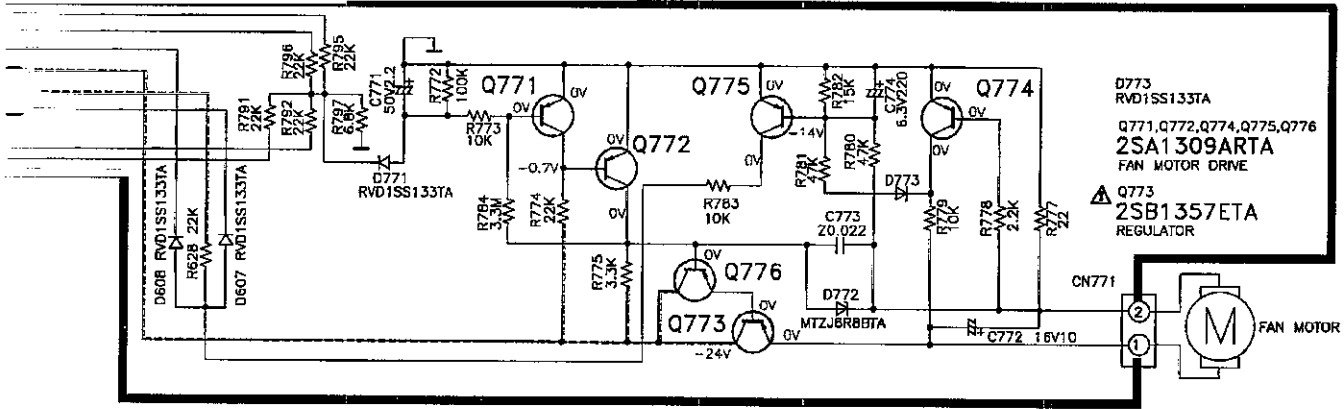

I IN/OUT TERMINAL CIRCUIT

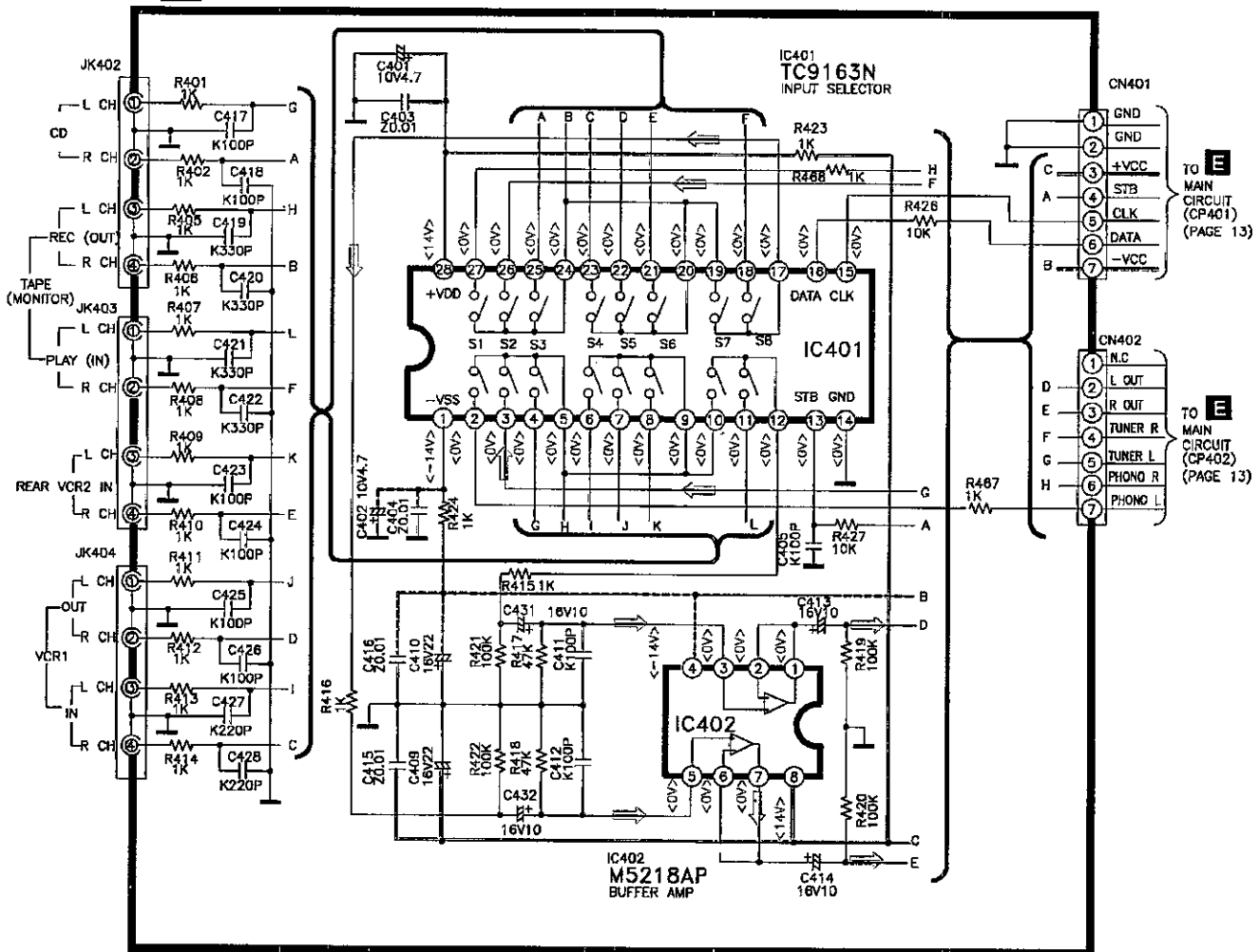

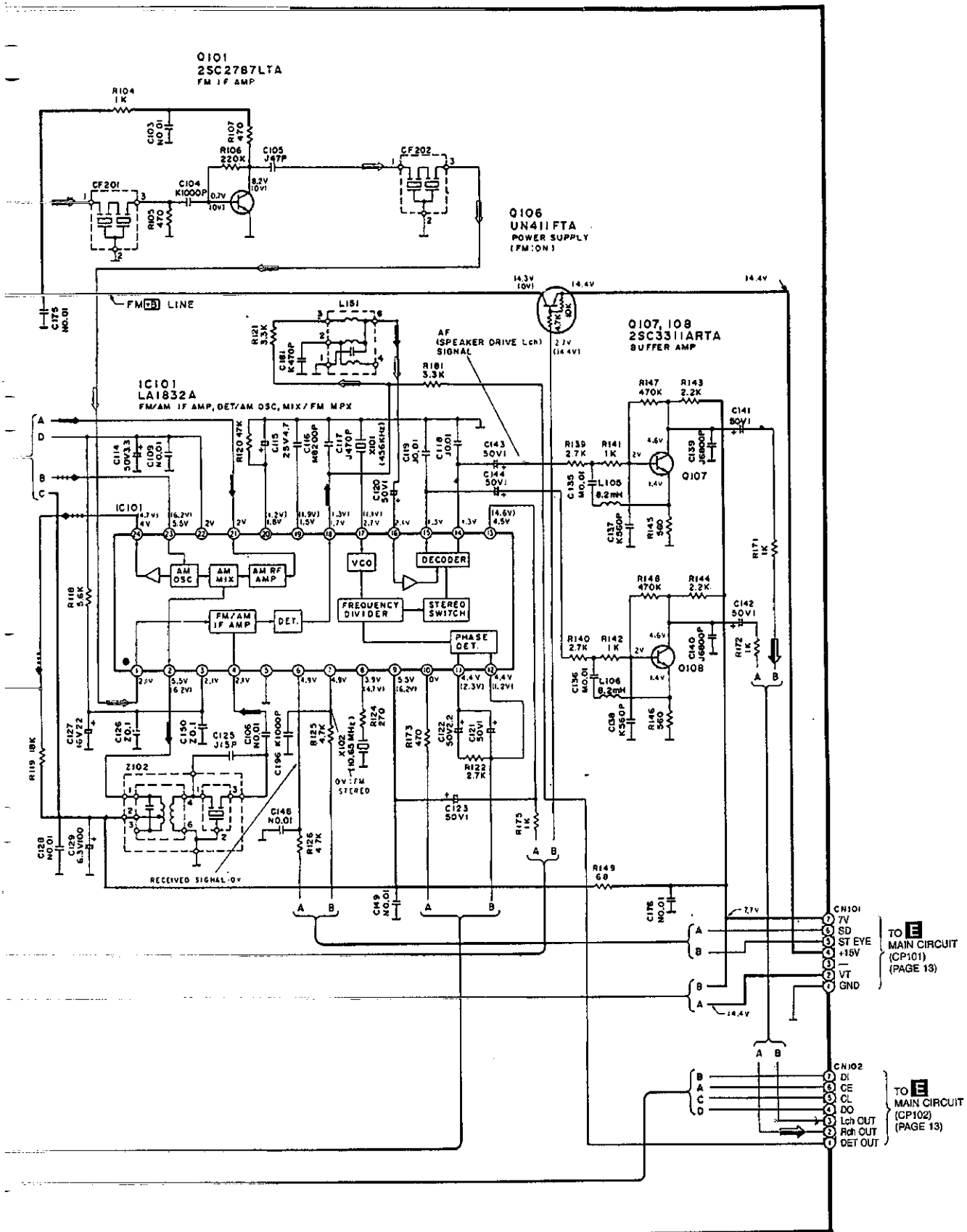

A TUNER CIRCUIT For (E) & (EB) areas

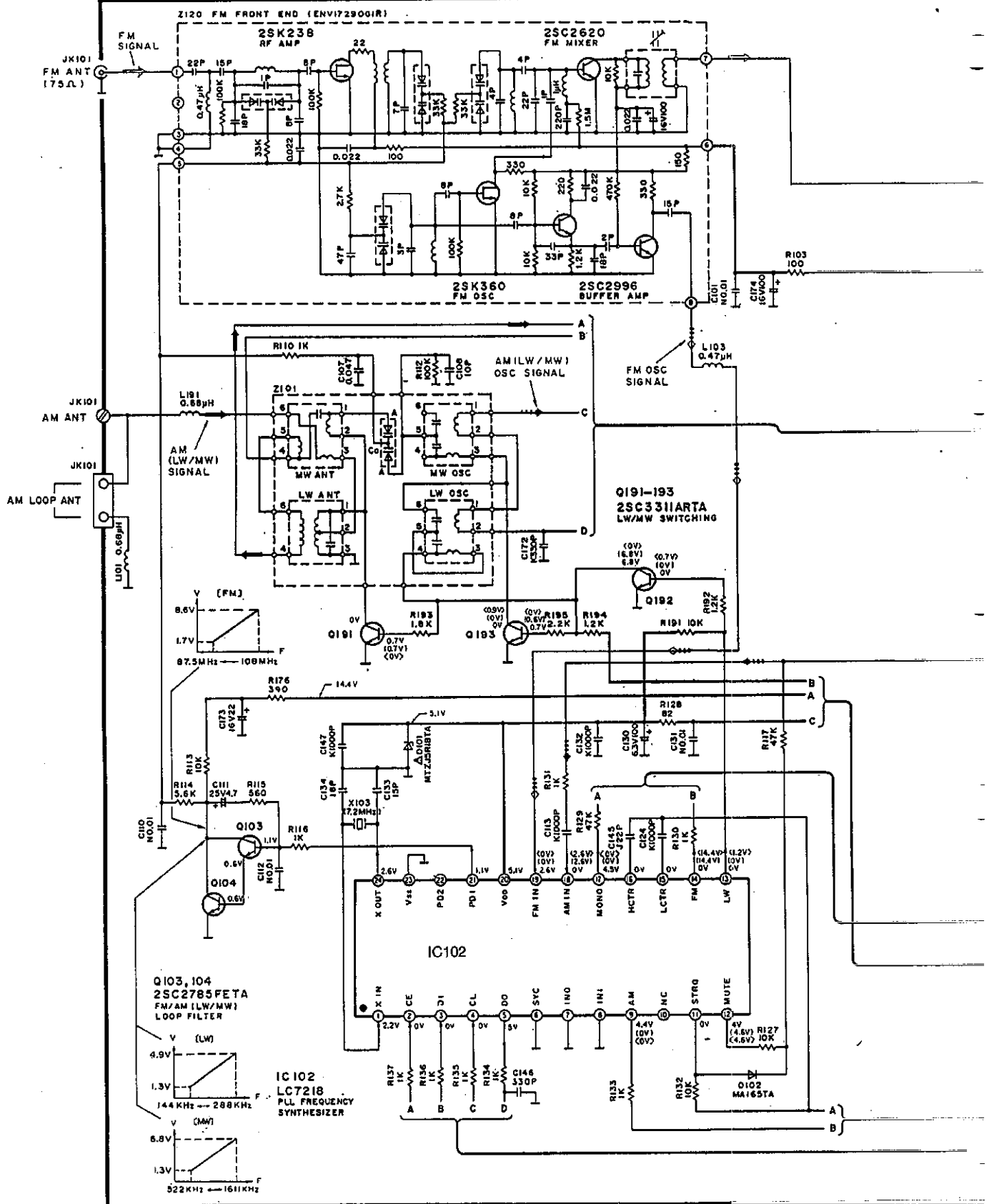

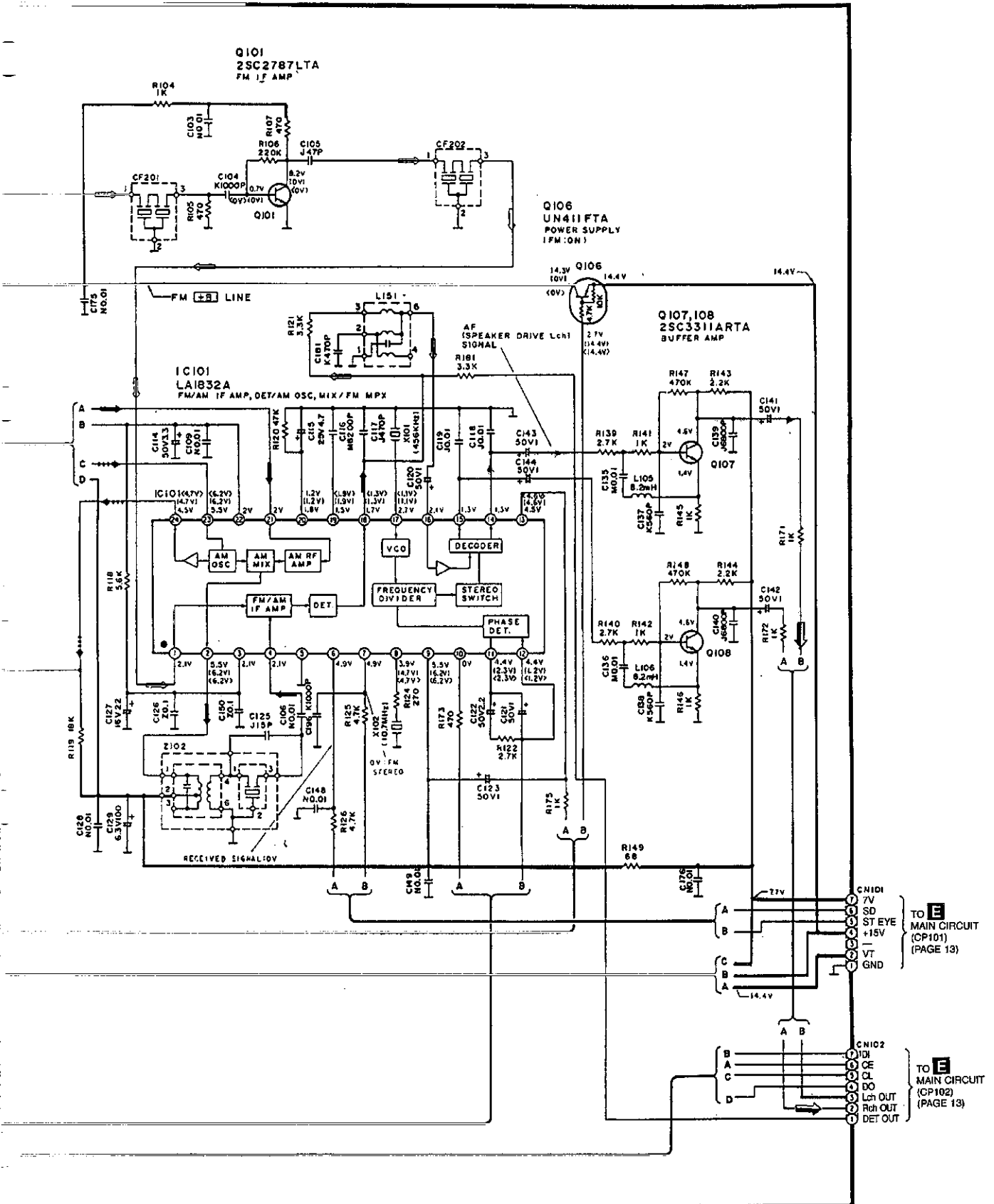

F POWER SUPPLY CIRCUIT

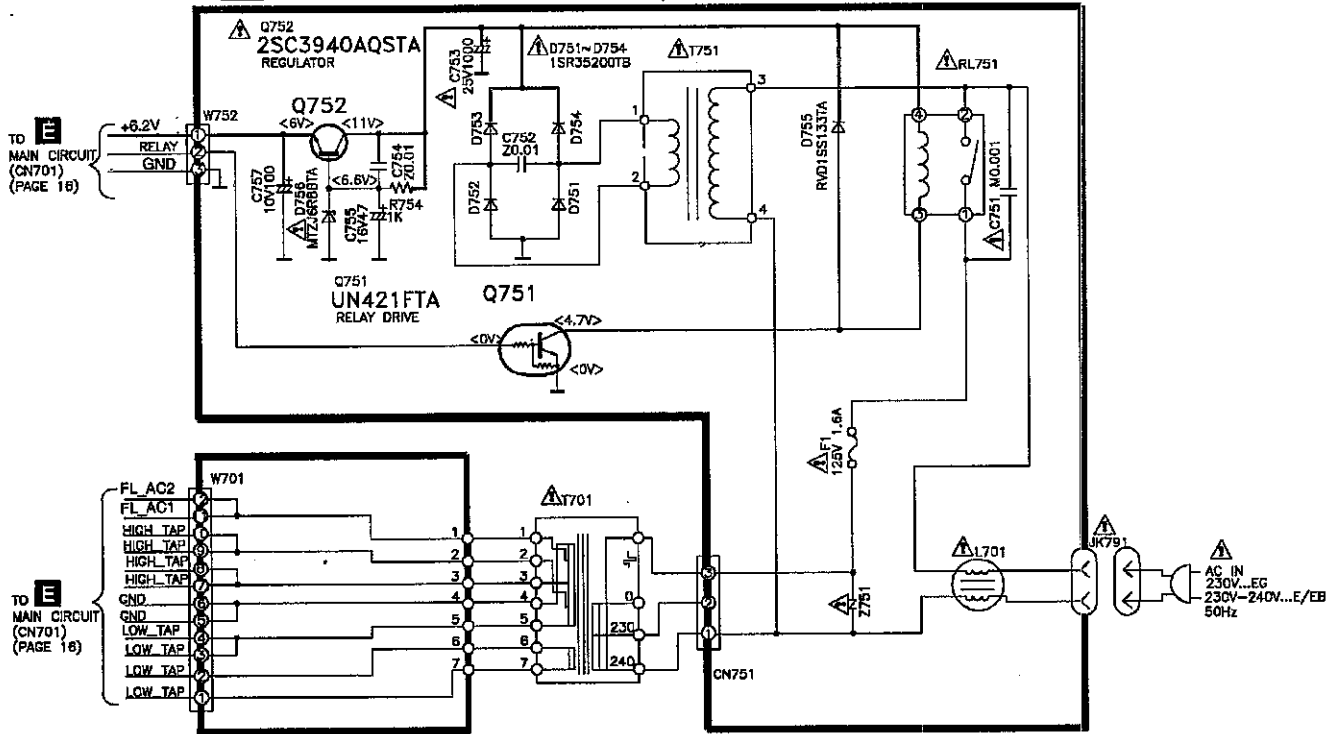

G TRANSFORMER CIRCUIT

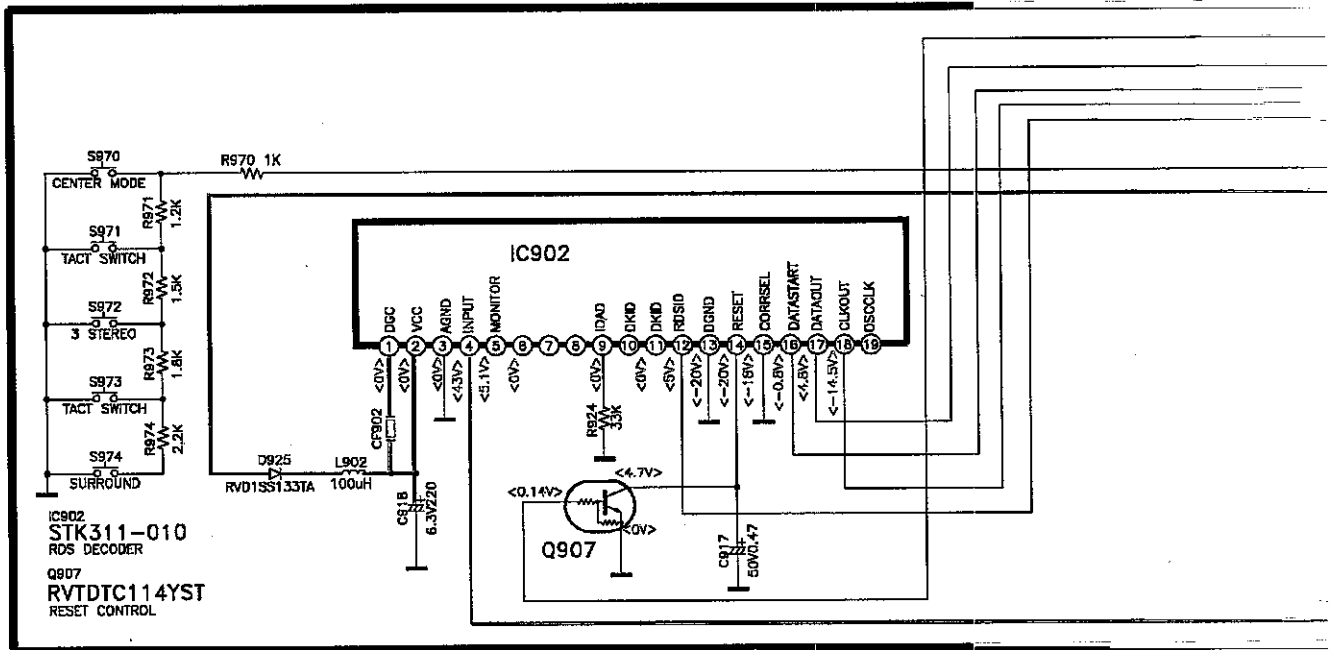

B PANEL CIRCUIT

E TO MAIN CIRCUIT (CN901) (PAGE 14)

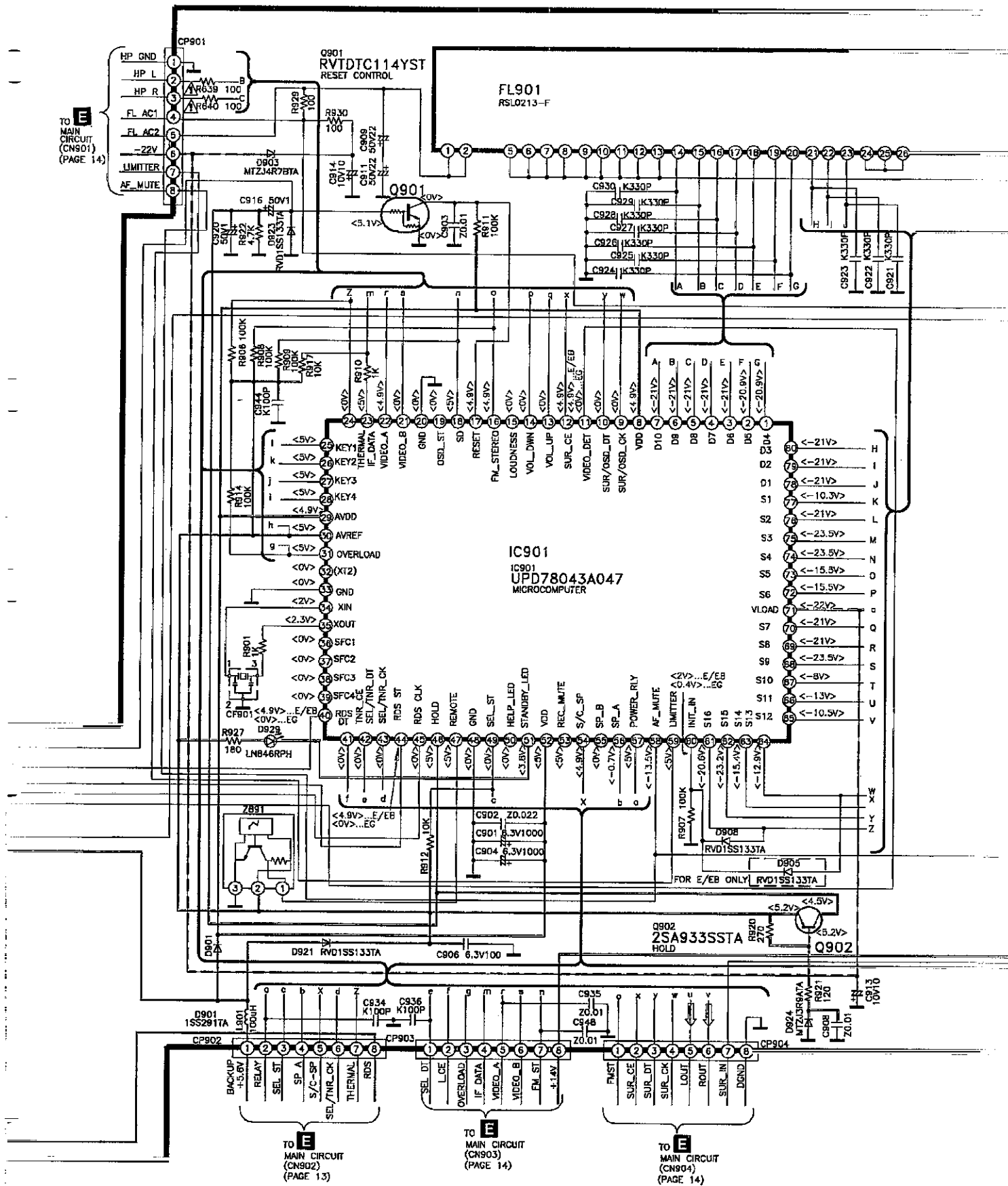

E TO MAIN CIRCUIT (CN902) (PAGE 13)

E TO MAIN CIRCUIT (CN903) (PAGE 14)

E TO MAIN CIRCUIT (CN904) (PAGE 14)

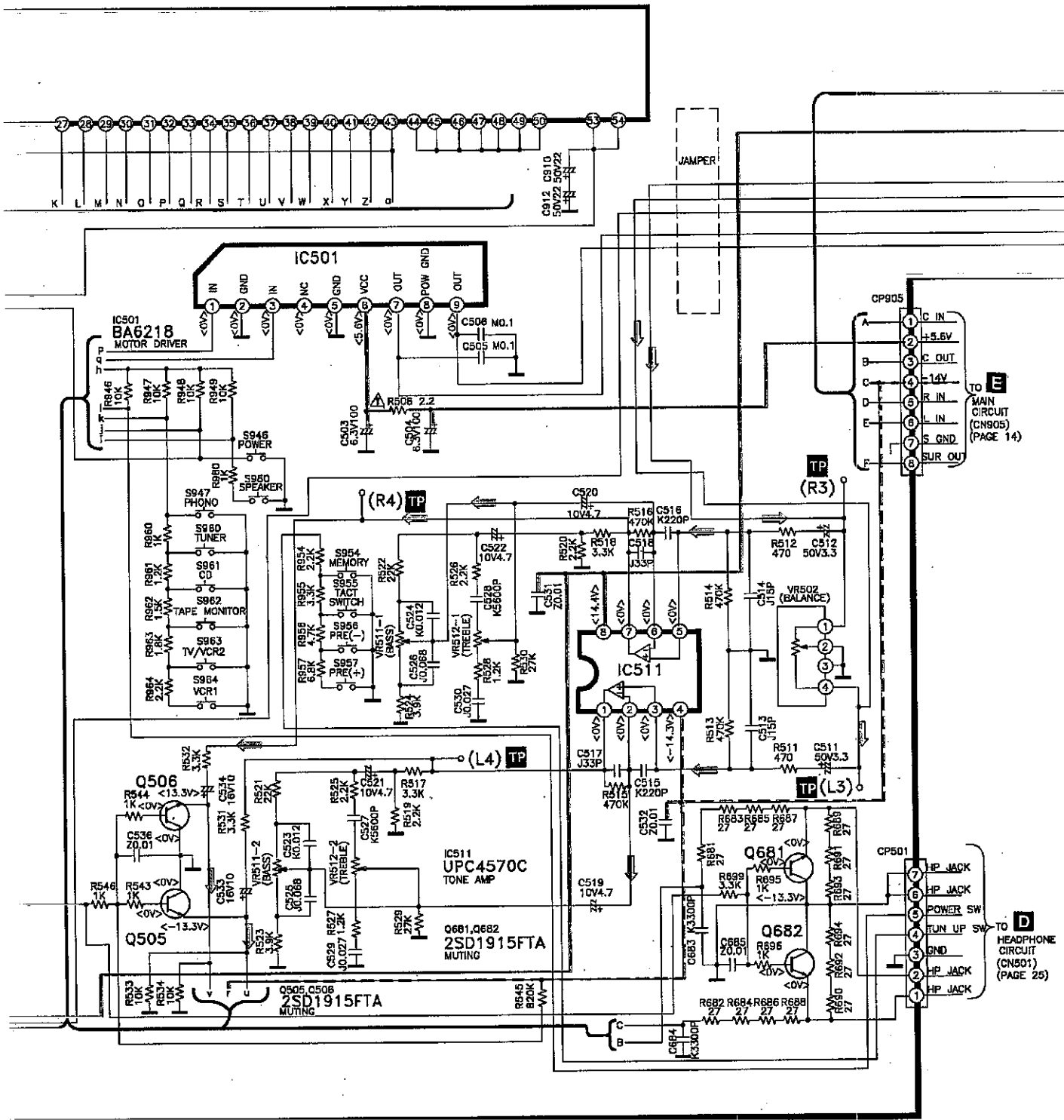

C VOLUME CIRCUIT

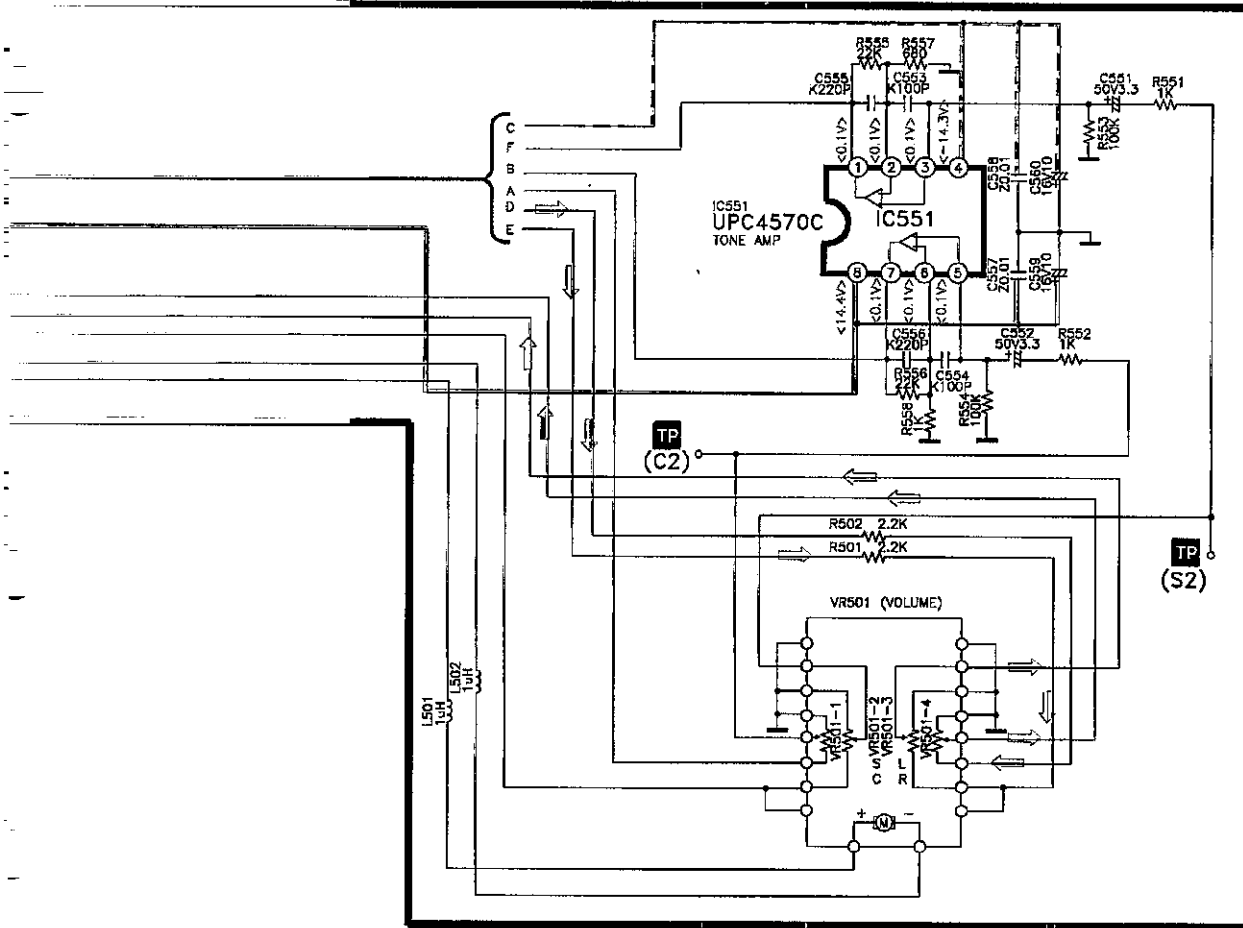

D HEADPHONE JACK CIRCUIT

H OPERATION CIRCUIT

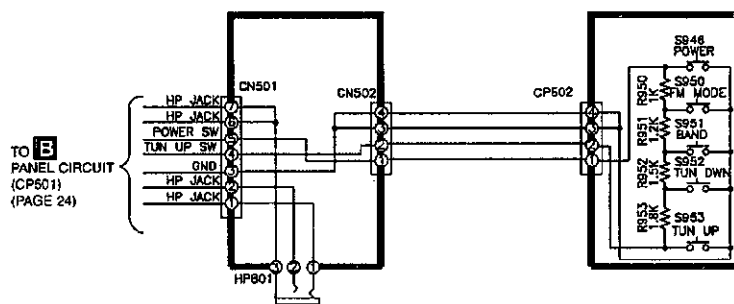

Block Diagram

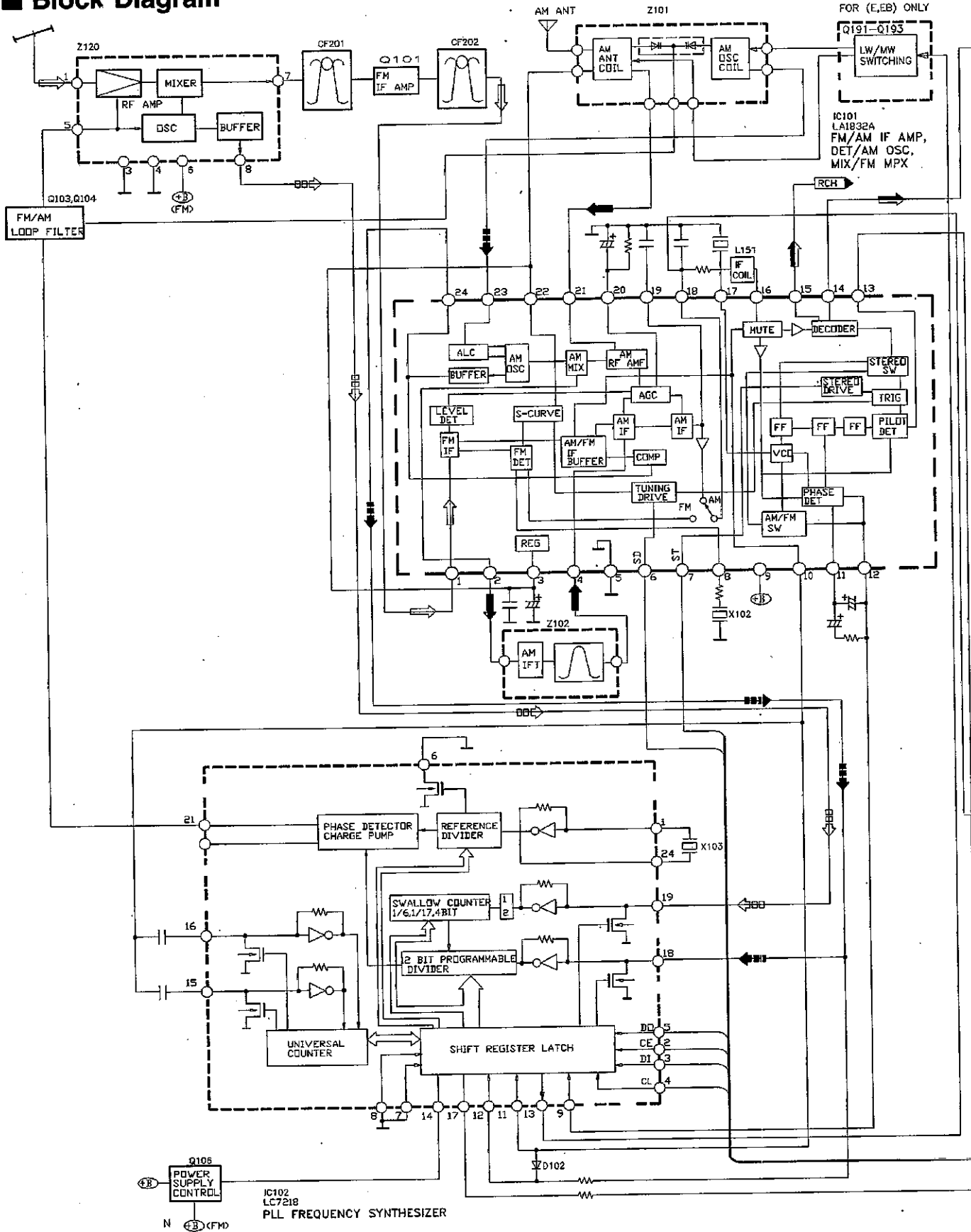

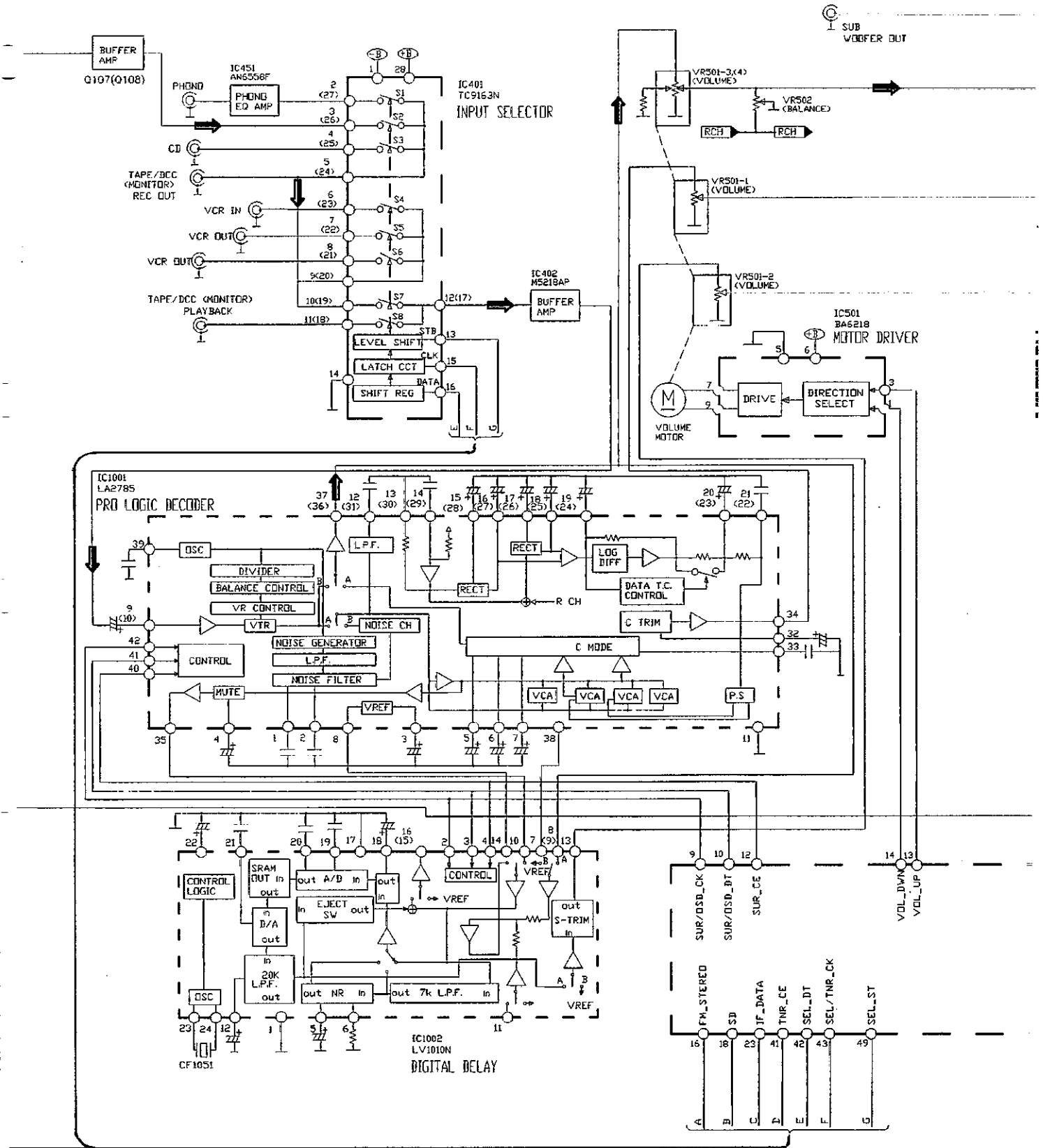

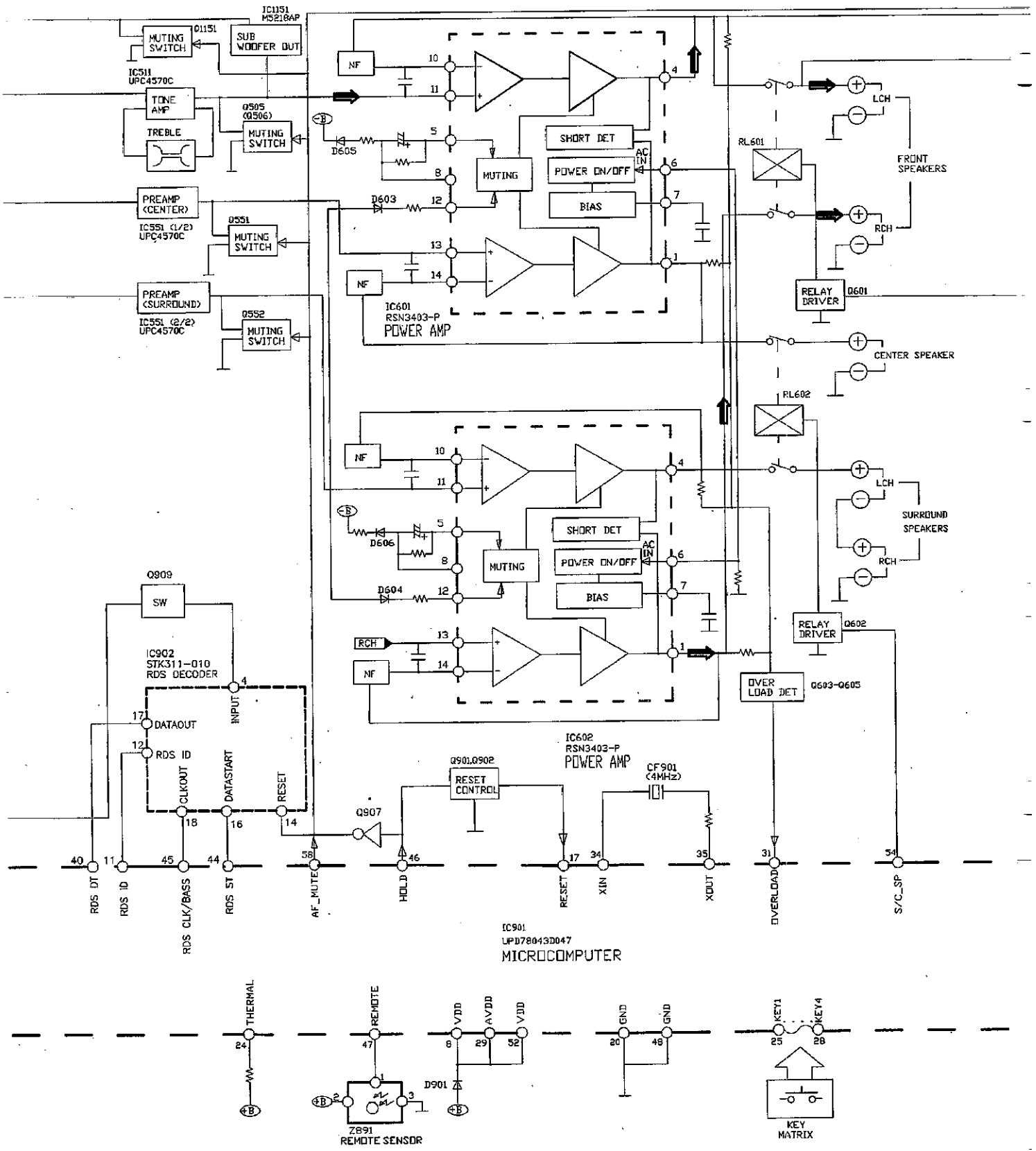

IC901
UPD78043D047
MICROCOMPUTER

ZB91
REMOTE SENSOR

KEY MATRIX

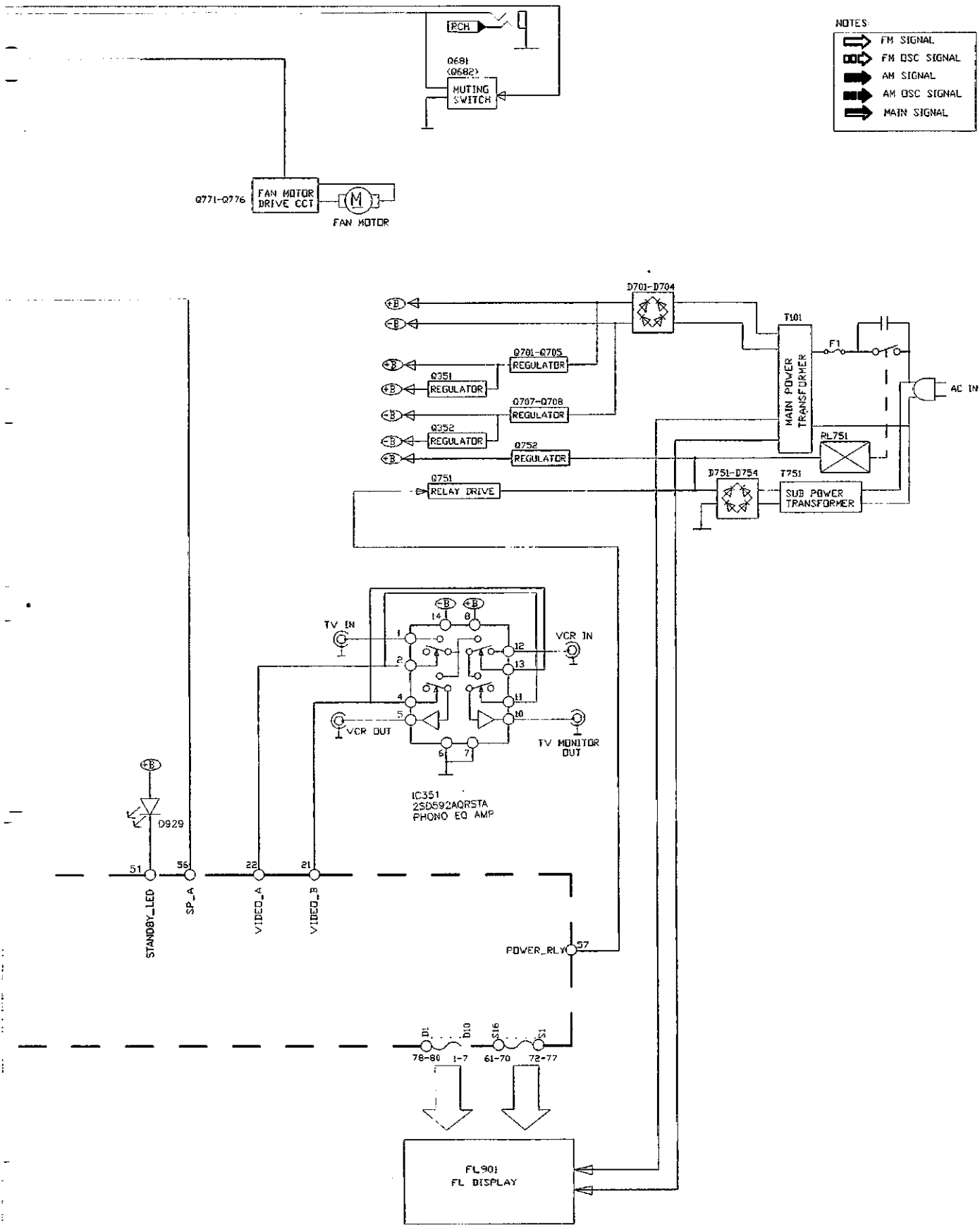

Wiring Connection Diagram

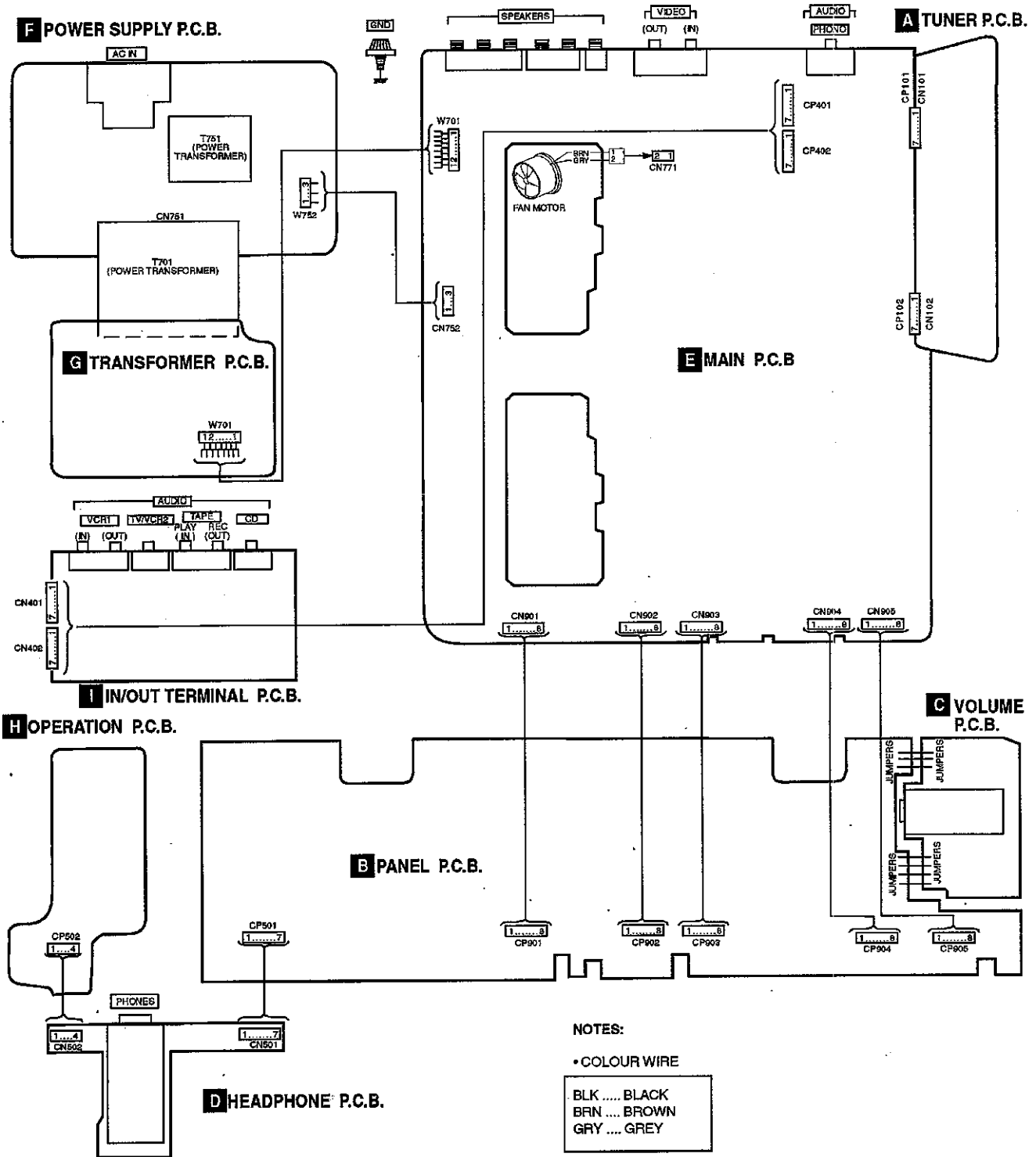

Printed Circuit Board

A TUNER P.C.B. (REP2158A-T .. EG)

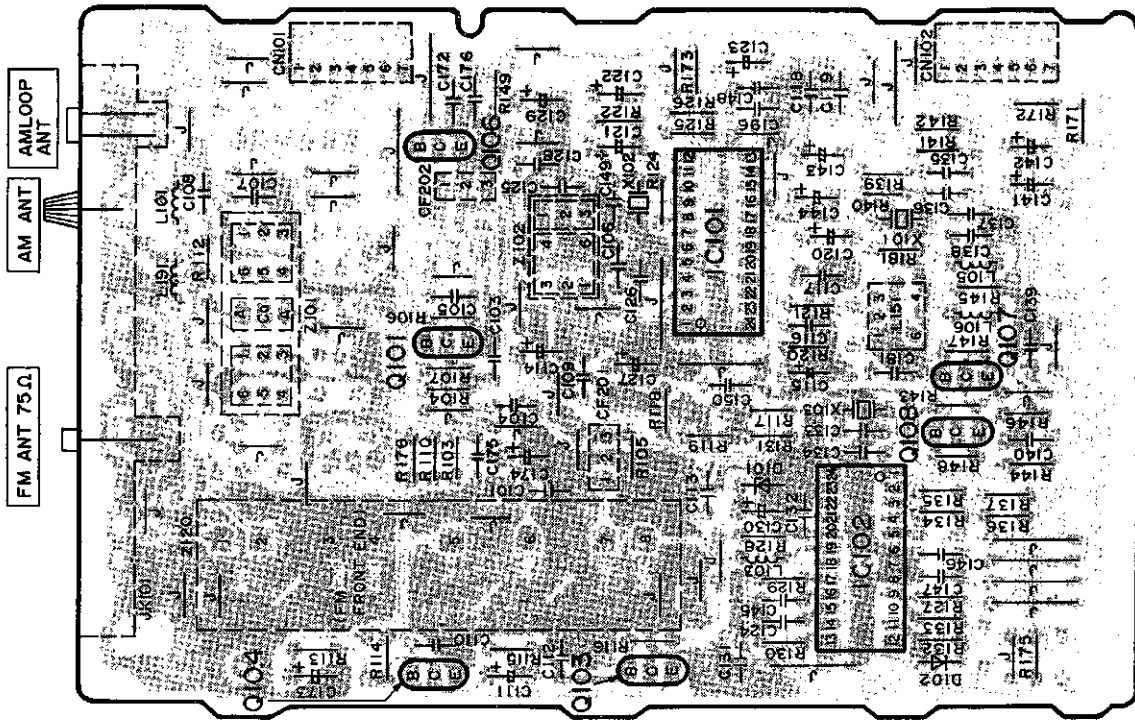

A TUNER P.C.B. (REP2158B-T .. E,EB)

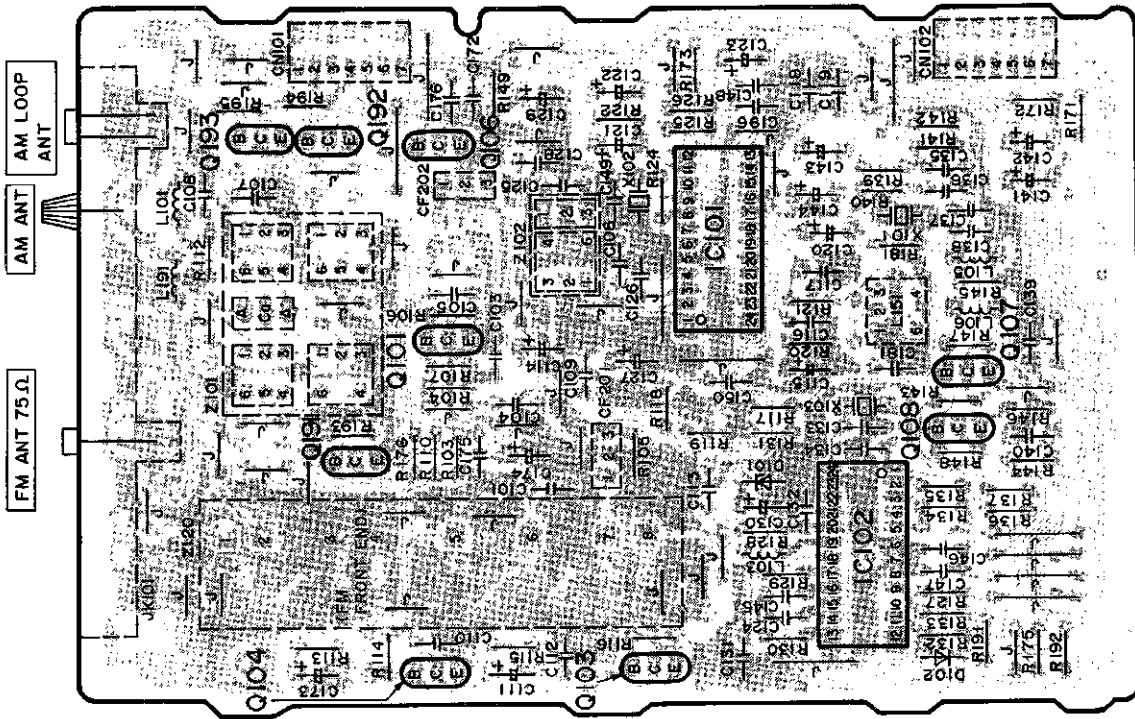

C VOLUME P.C.B. (REP2256B-S .. E,EB) (REP2256C-S .. EG)

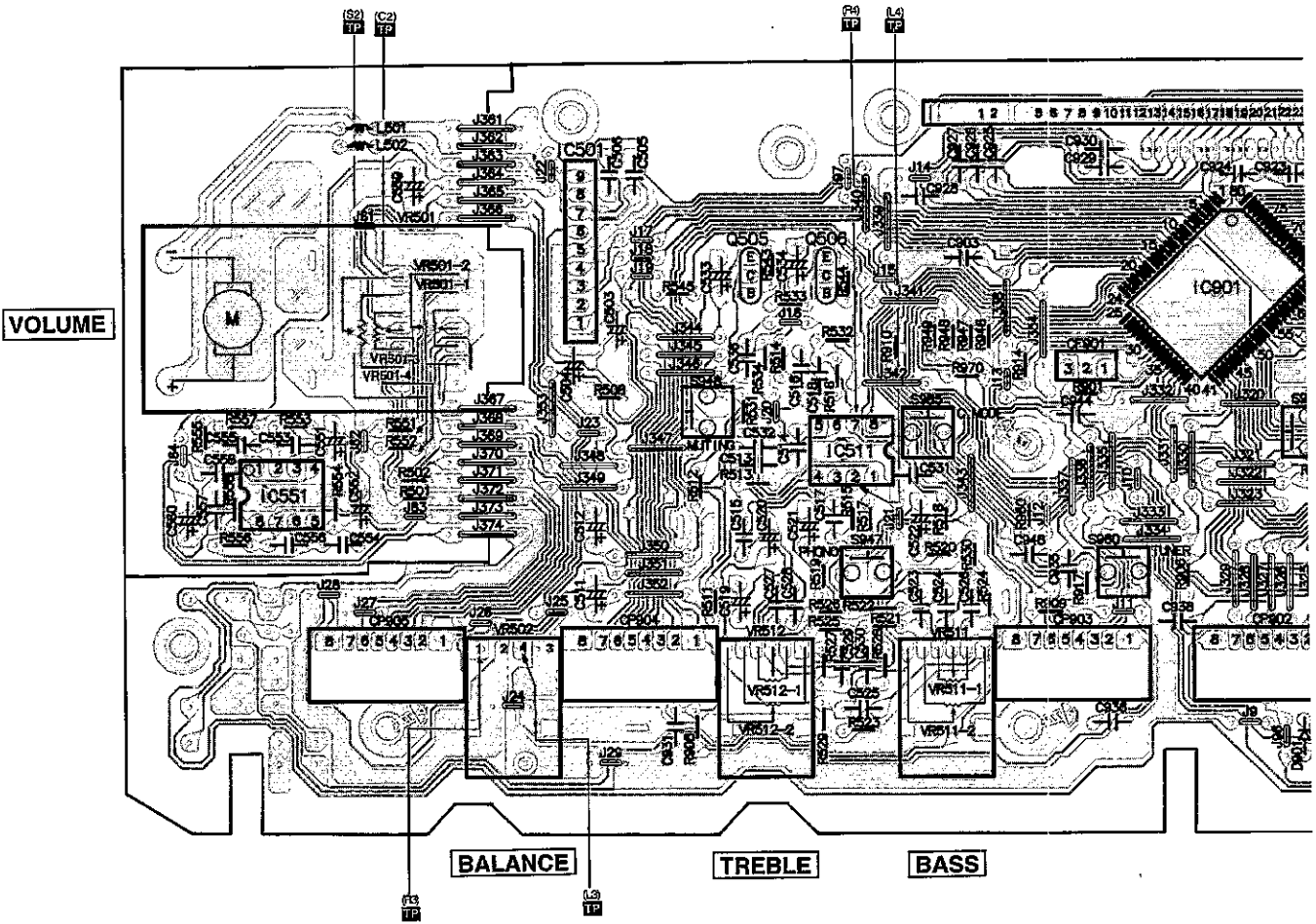

D HEADPHONES JACK P.C.B. (REP2256B-S .. E,EB) (REP2256C-S .. EG)

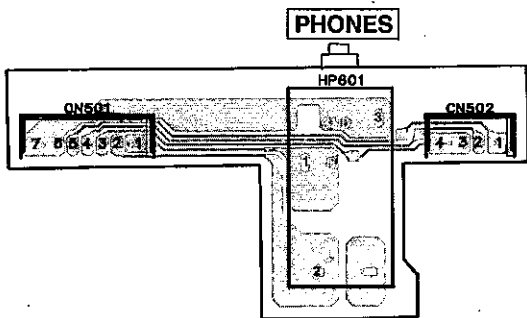

H OPERATION P.C.B. (REP2256B-S .. E,EB) (REP2256C-S .. EG)

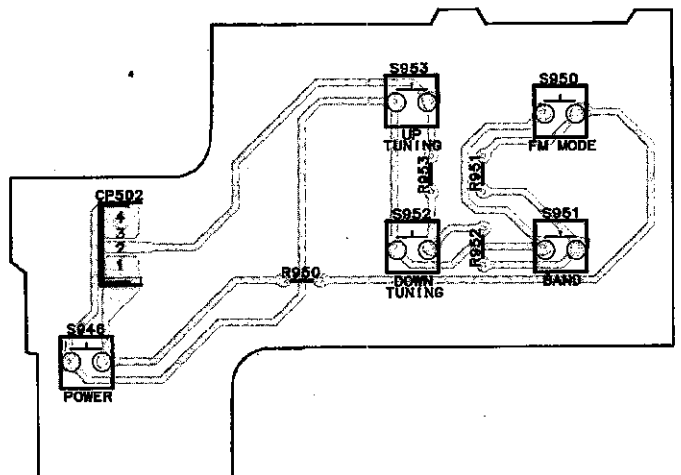

B PANEL P.C.B. (REP2256B-S .. E,EB) (REP2256C-S .. EG)

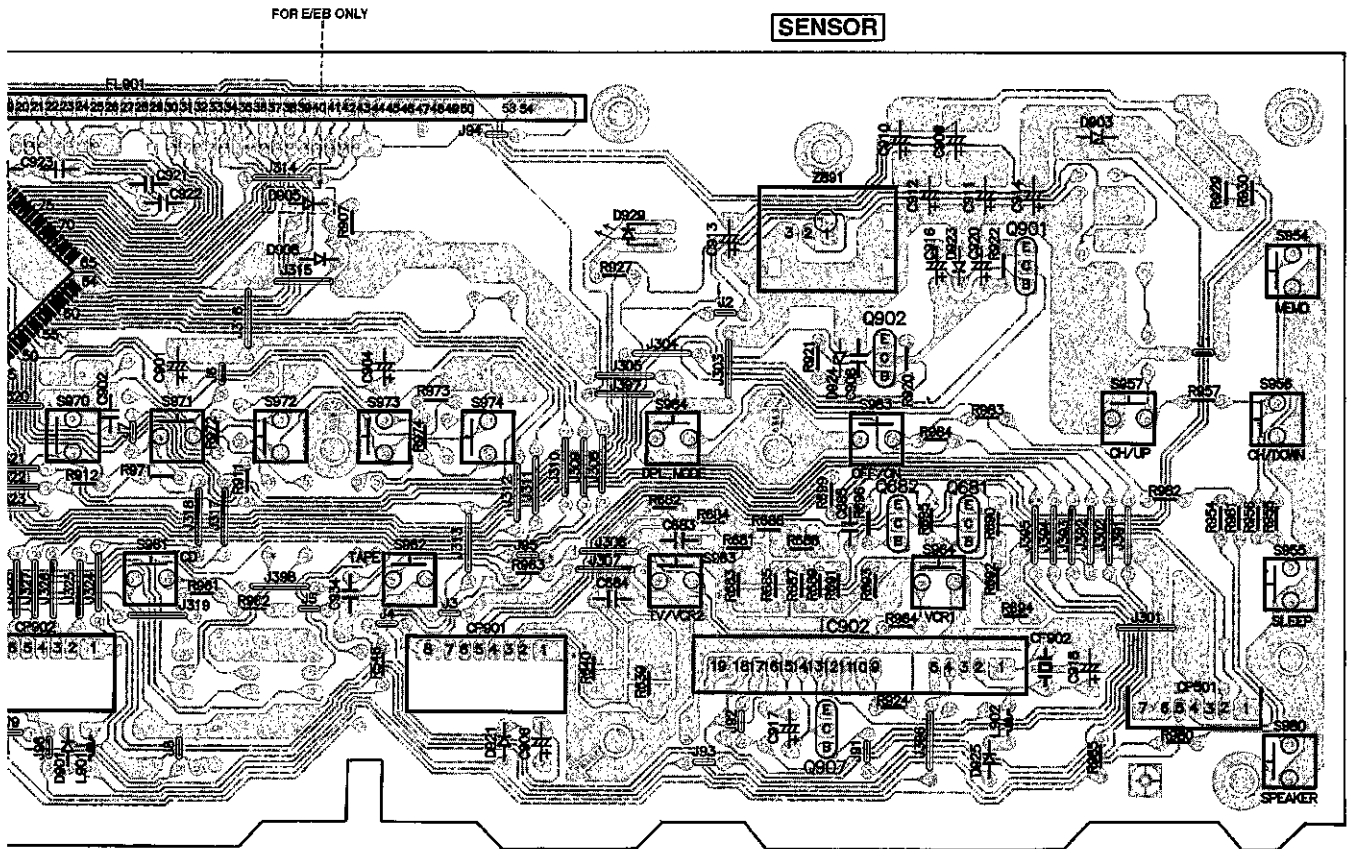

I IN/OUT TERMINAL P.C.B. (REP2255B-M)

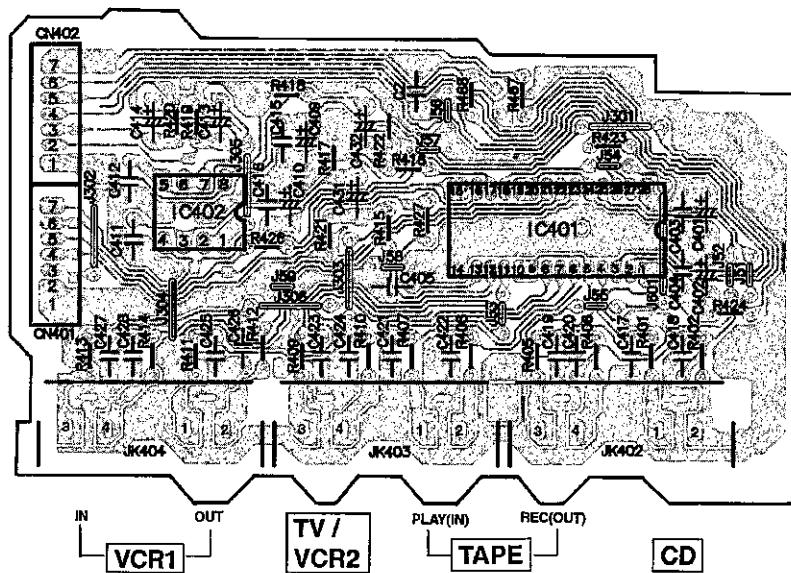

E MAIN P.C.B. (REP2255B-M)

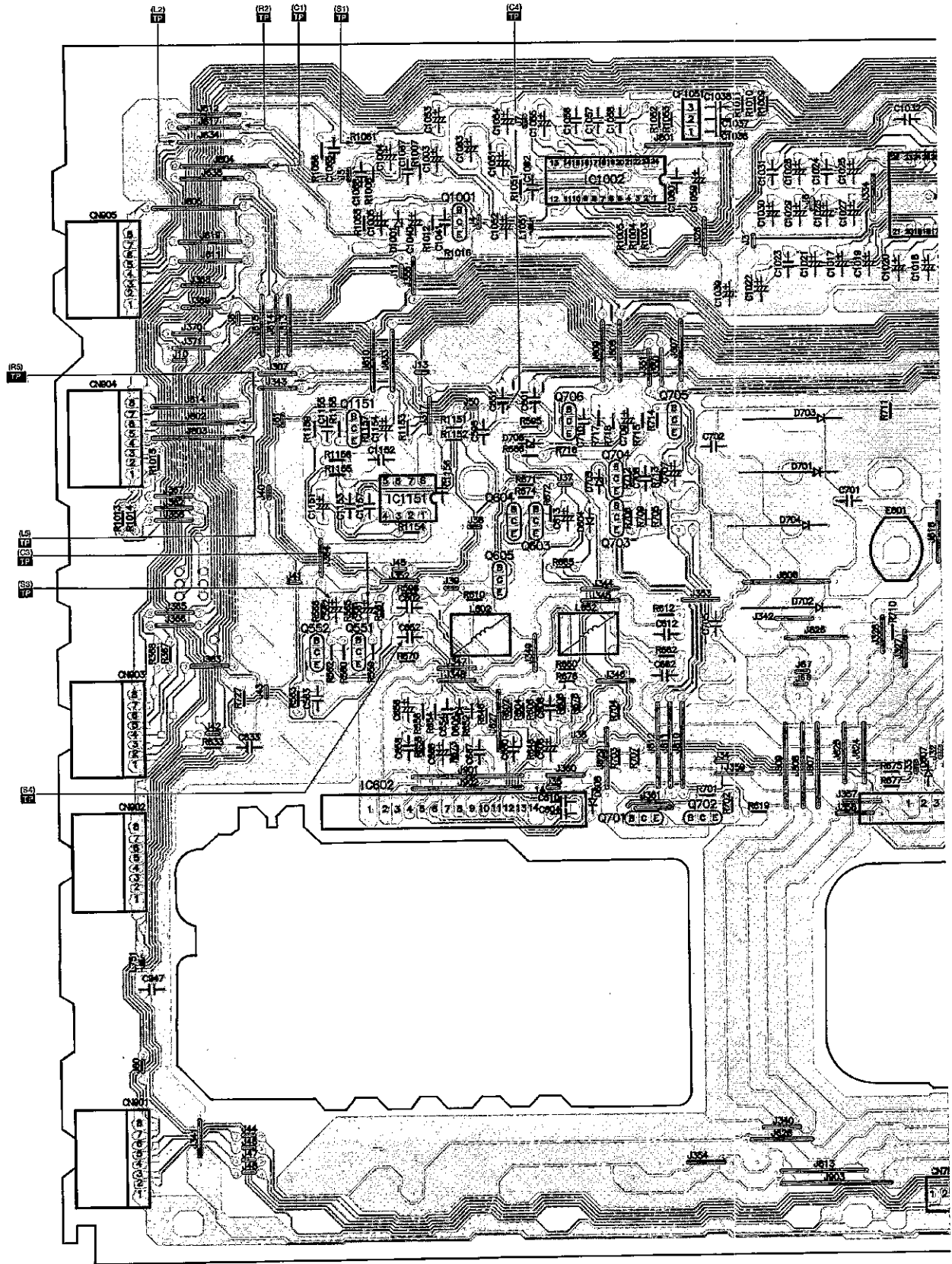

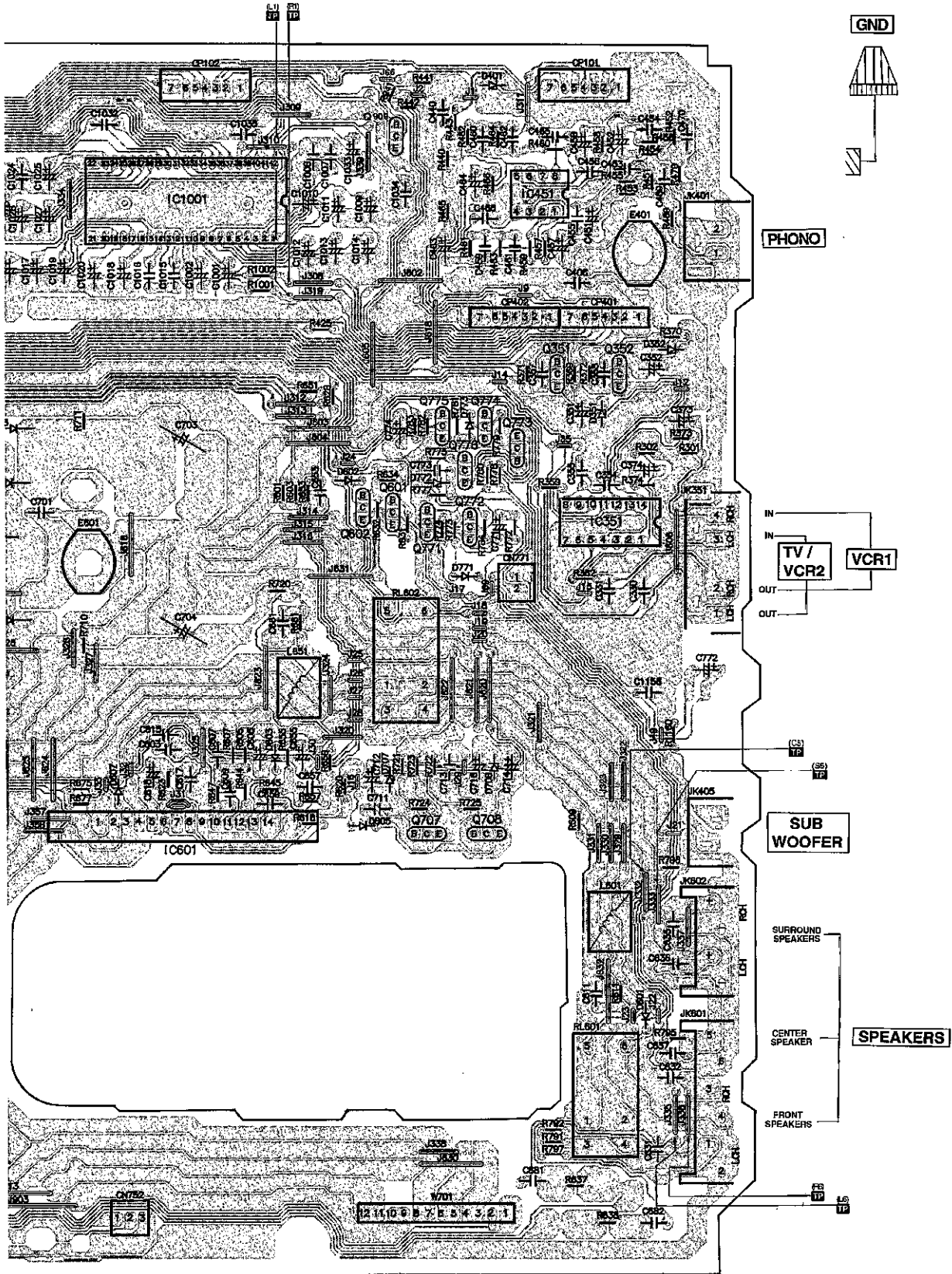

F POWER SUPPLY P.C.B. (REP2257B-P .. E,EB)

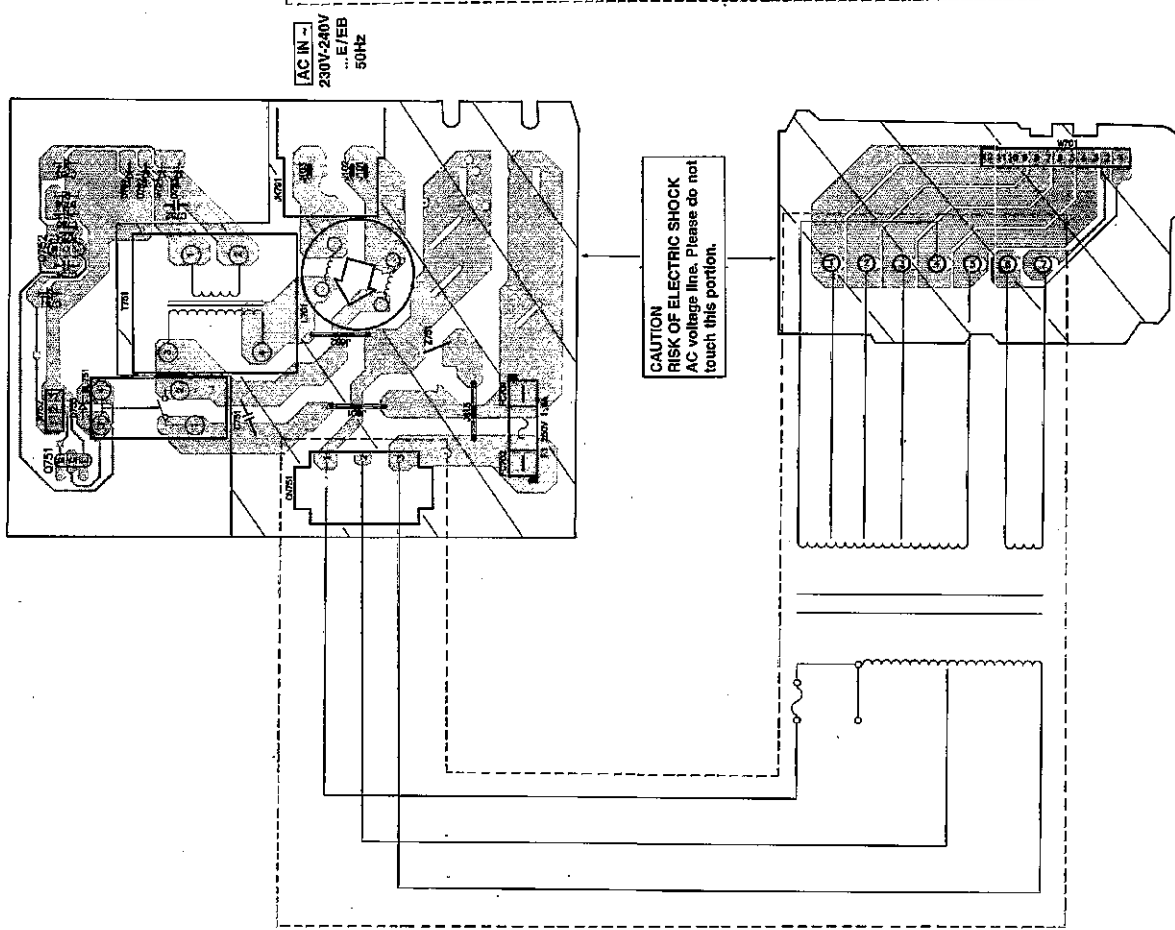

G TRANSFORMER P.C.B. (REP2257B-P .. E,EB)

F POWER SUPPLY P.C.B. (REP2257C-P .. EG)

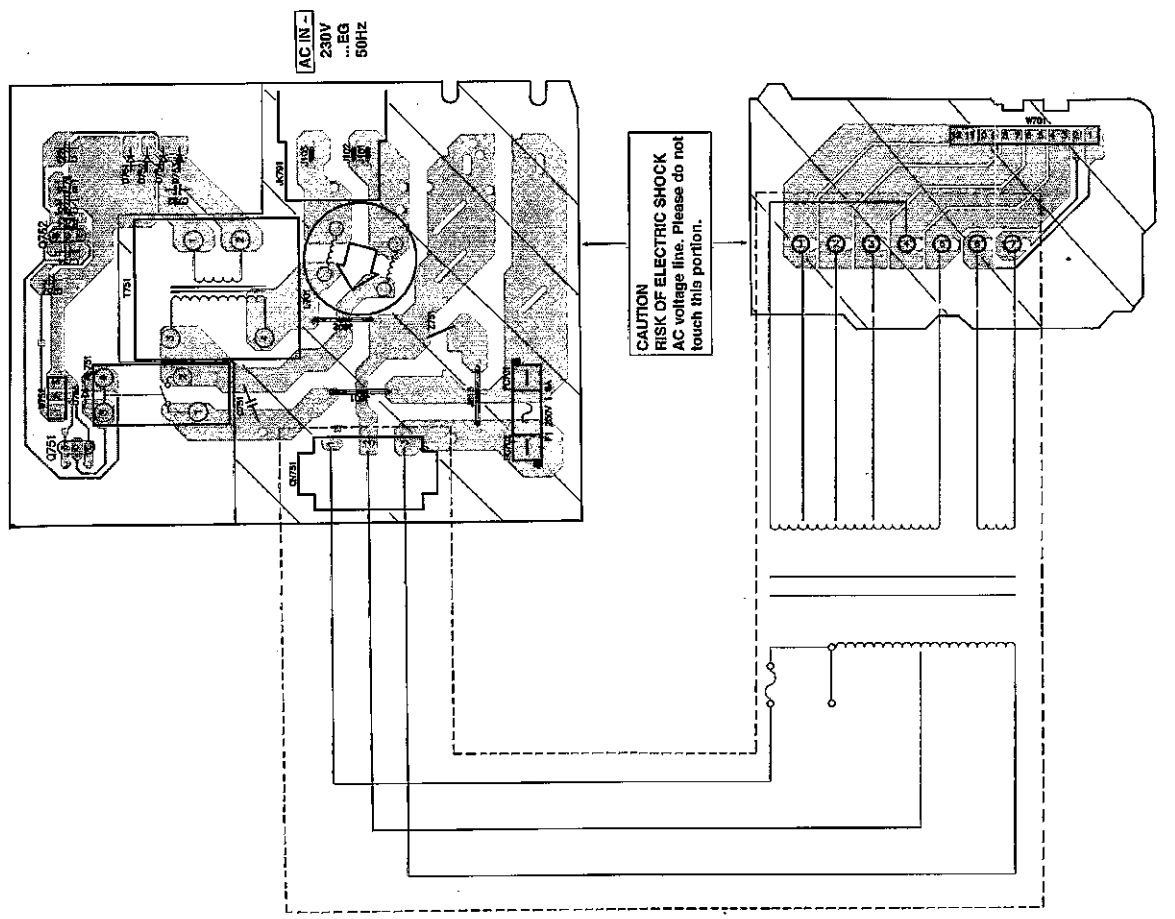

G TRANSFORMER P.C.B. (REP2257C-P .. EG)

Cabinet Parts Location

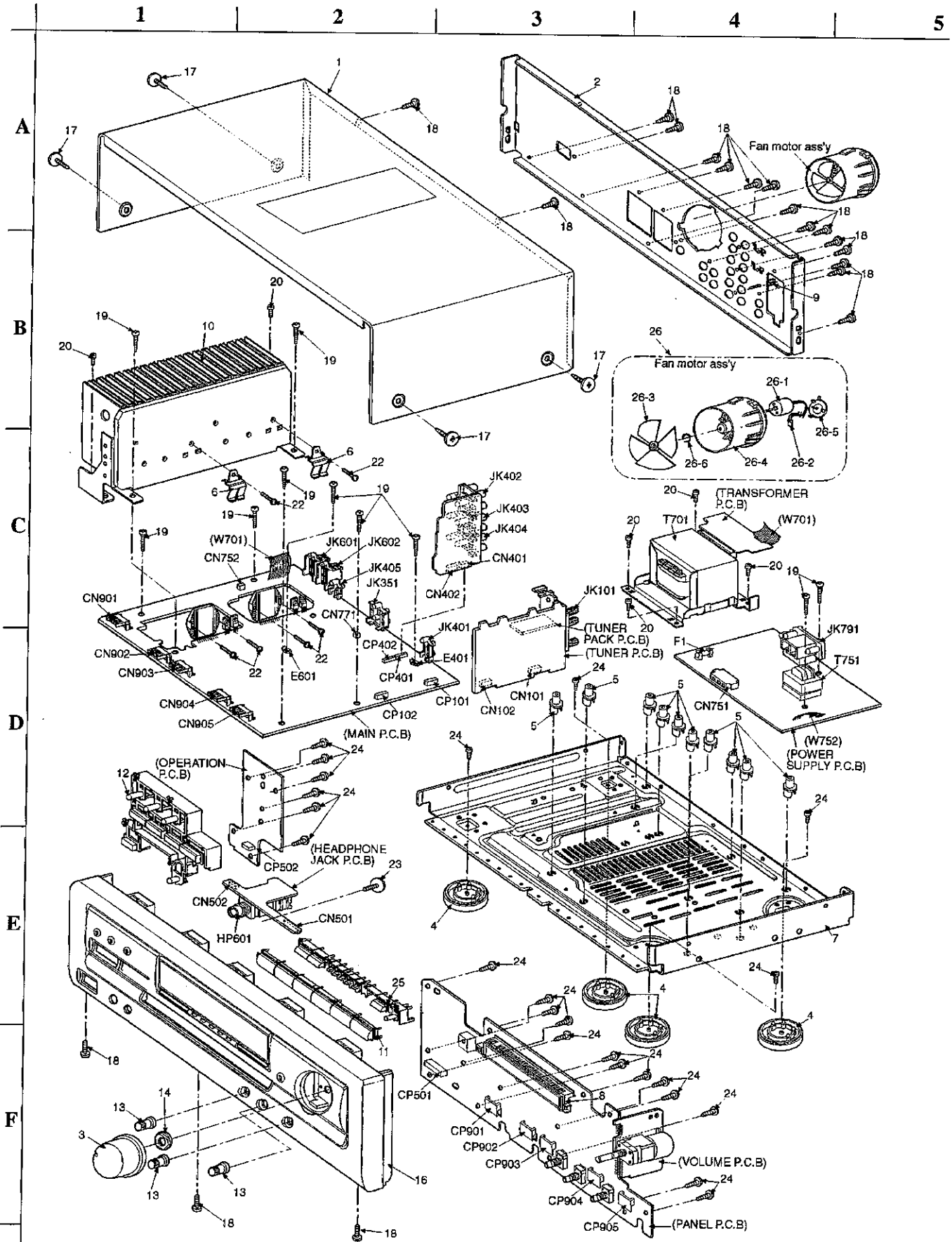

■ Replacement Parts List

Notes: • Important safety notice:

 Components identified by Δ mark have special characteristics important for safety.

Furthermore, special parts which have purposes of fire-retardant (resistors), high-quality sound (capacitors), low-noise (resistors), etc. are used. When replacing any of components, be sure to use only manufacturer's specified parts shown in the parts list.

- The parenthesized in the Remarks columns specify the areas. (Refer to the cover page for area.) Parts without these indication can be used for all areas.
- [M] in Remarks column indicates parts that are supplied by MESA.
- [MAV] in Remarks column indicates parts that are supplied by MAV.
- Remote Control Unit: Supply period for three years from terminal of production.
- The "(SF)" mark denotes the standard part.
- [VRD] indicates in Remarks column parts that are supplied by Video Recorder Division.

Ref.No.	Part.No.	Part Name & Description	Remarks	Ref.No.	Part.No.	Part Name & Description	Remarks	Ref.No.	Part.No.	Part Name & Description	Remarks
				IC351	NJM2279D	IC, VIDEO SELECTOR SW		Q702	2SD2374PQAU	TRANSISTOR	Δ
		CABINET AND CHASSIS		IC401	TC9163N	IC, SELECTOR		Q703	2SC2631QRSTA	TRANSISTOR	
				IC402	M5218AP	IC, BUFFER AMP		Q704	2SC3311ARTA	TRANSISTOR	
1	RKM0319B-K	CABINET	[MAV]	IC451	AN6558-F	IC, PHONO EQ AMP	[M]	Q705	2SC3311ARTA	TRANSISTOR	
2	RGR0234C-B1	REAR PANEL	[MAV](E)	IC501	BA6218	IC, MOTOR DRIVER		Q706	2SC3940AQSTA	TRANSISTOR	Δ
2	RGR0234C-C	REAR PANEL	[MAV](EB)	IC511	UPC4570C	IC, TONE CONTROL		Q707	2SB1548PQAU	TRANSISTOR	Δ
2	RGR0234C-A	REAR PANEL	[MAV](EG)	IC551	UPC4570C	IC, TONE CONTROL		Q708	2SB1548PQAU	TRANSISTOR	Δ
3	RGW0243A-K	VOLUME KNOB	[MAV]	IC601	RSN3403-P	IC, HIC	[MAV] Δ	Q751	UN421FTA	TRANSISTOR	
4	RKA0079-A	FOOT	[MAV]	IC602	RSN3403-P	IC, HIC	[MAV] Δ	Q752	2SC3940AQSTA	TRANSISTOR	Δ
5	RKQ0089	PCB SUPPORT		IC901	UPD78043A047	IC, MICRO COMPUTER	[MAV]	Q771	2SA1309ARTA	TRANSISTOR	
6	RMC0158-S	TR FIXTURE	[M]	IC902	STK311-010	IC, RDS DECODER	[M]	Q772	2SA1309ARTA	TRANSISTOR	
7	RMK0313	BOTTOM CHASSIS	[MAV]	IC1001	LA278S	IC, PRO LOGIC DECODER		Q773	2SB1357ETA	TRANSISTOR	[M] Δ
8	RMN0372	FL HOLDER	[MAV]	IC1002	LV1010N	IC, DIGITAL DELAY		Q774	2SA1309ARTA	TRANSISTOR	
9	SNE2123	EARTH TERMINAL		IC1151	M5218AP	IC, BUFFER AMP		Q775	2SA1309ARTA	TRANSISTOR	
10	RXX0166	HEAT SINK UNIT	[MAV]					Q776	2SA1309ARTA	TRANSISTOR	
11	RGU1351-K	SELECTOR BUTTON	[MAV]			TRANSISTORS		Q901	RVTDTIC114YST	TRANSISTOR	
12	RGU1350A-K	MODE BUTTON	[MAV]					Q902	2SA933SSTA	TRANSISTOR	
13	RGW0244-K	BASS TREBLE KNOB	[MAV]	Q101	2SC2787LTA	TRANSISTOR		Q907	RVTDTIC114YST	TRANSISTOR	
14	RHN90001	M9 NUT		Q103	2SC2785PETA	TRANSISTOR		Q909	2SC3311ARTA	TRANSISTOR	
16	RFKGEX300EK	FRONT PANEL ASS'Y	[MAV]	Q104	2SC2785PETA	TRANSISTOR		Q1001	2SC3940AQSTA	TRANSISTOR	Δ
17	SNE2129-1	SCREW (CABINET)		Q106	UN411FTA	TRANSISTOR		Q1151	2SD1915FTA	TRANSISTOR	
18	XTBS3+8FZ1	SCREW (REAR PANEL)		Q107	2SC3311ARTA	TRANSISTOR					
19	XTB3+20IFZ	SCREW (MAIN PCB)		Q108	2SC3311ARTA	TRANSISTOR				DIODES	
20	XTB3+8FFZ	SCREW (TRNF/MH SINK)		Q191	2SC3311ARTA	TRANSISTOR	(E,EB)				
22	XTW3+15T	SCREW (HIC/FIXTURE)		Q192	2SC3311ARTA	TRANSISTOR	(E,EB)	D101	MTZ15R1BTA	DIODE	
23	RHD26016	SCREW (H. PHONES)		Q193	2SC3311ARTA	TRANSISTOR	(E,EB)	D102	MA165TA	DIODE	
24	XTBS26+10I	SCREW (FRONT PANEL)		Q351	2SD592AQRSTA	TRANSISTOR		D351	MTZ15R6BTA	DIODE	
25	RGU1352F-K	DOLBY BUTTON	[MAV]	Q352	2SB621ARTA	TRANSISTOR		D352	MTZ15R6BTA	DIODE	
26	RYQ0173-K	FAN UNIT	[MAV]	Q505	2SD1915FTA	TRANSISTOR		D401	MTZ17R5CTA	DIODE	
26-1	MDN-4RB4MRC	MOTOR		Q506	2SD1915FTA	TRANSISTOR		D601	RVD1SS133TA	DIODE	
26-2	REX0811	CONNECTOR UNIT	[MAV]	Q551	2SD1915FTA	TRANSISTOR		D602	RVD1SS133TA	DIODE	
26-3	SHE232-1	64MM PROPELLER		Q552	2SD1915FTA	TRANSISTOR		D603	RVD1SS133TA	DIODE	
26-4	SHE233-1	FAN CASE		Q601	2SA1309ARTA	TRANSISTOR		D604	RVD1SS133TA	DIODE	
26-5	SHE234	FAN CASE COVER		Q602	2SA1309ARTA	TRANSISTOR		D605	RVD1SS133TA	DIODE	
26-6	SUS271	MOTOR SPRING		Q603	2SC3311ARTA	TRANSISTOR		D606	RVD1SS133TA	DIODE	
				Q604	2SC3311ARTA	TRANSISTOR		D607	RVD1SS133TA	DIODE	
		INTEGRATED CIRCUITS		Q605	2SC3311ARTA	TRANSISTOR		D608	RVD1SS133TA	DIODE	
				Q681	2SD1915FTA	TRANSISTOR		D701	1N5402BM21	DIODE	Δ
IC101	LA1832A	IC, IF/MPX		Q682	2SD1915FTA	TRANSISTOR		D702	1N5402BM21	DIODE	Δ
IC102	LC7218	IC, PLL		Q701	2SD2374PQAU	TRANSISTOR	Δ	D703	1N5402BM21	DIODE	Δ

RefNo	Part No.	Part Name & Description	Remarks	Ref No	Part No.	Part Name & Description	Remarks	Ref No	Part No.	Part Name & Description	Remarks
D704	1N5402BM2I	DIODE	▲	S964	EVQ21405R	SW, VCR1		L501	RLQZP1R0KT-Y	AXIAL COIL	
D705	MTZJ6R2BTA	DIODE		S970	EVQ21405R	SW,SEARCH		L502	RLQZP1R0KT-Y	AXIAL COIL	
D706	MTZJ6R2BTA	DIODE	▲	S971	EVQ21405R	SW,EON		L601	RLQYR73M	CHOKE COIL	
D707	MTZJ24DTA	DIODE	▲	S972	EVQ21405R	SW,PTY SEL A		L602	RLQYR73M	CHOKE COIL	
D708	MTZJ15CTA	DIODE	▲	S973	EVQ21405R	SW,PTY SEL V		L651	RLQYR73M	CHOKE COIL	
D751	1SR35200TB	DIODE	▲	S974	EVQ21405R	SW,DISPLAY MODE		L652	RLQYR73M	CHOKE COIL	
D752	1SR35200TB	DIODE	▲	S980	EVQ21405R	SW, SPEAKER		L701	SLQZ650MH49	AC LINE COIL	
D753	1SR35200TB	DIODE	▲	S983	EVQ21405R	SW,SURROUND		L751	ELESN101KA	CHOKE COIL	
D754	1SR35200TB	DIODE	▲	S984	EVQ21405R	SW, SW, 3 STEREO		L901	RLQB101KTA-Y	CHOKE COIL	
D755	RVD1SS133TA	DIODE		S985	EVQ21405R	SW, CENTER MODE		L902	RLQZP101KT-Y	AXIAL COIL	
D756	MTZJ6R8BTA	DIODE	▲					L1051	ELESN101KA	CHOKE COIL	
D771	RVD1SS133TA	DIODE				CONNECTORS		T701	RTP1N5B023-V	POWER TRANSFORMER	(MAV)▲
D772	MTZJ6R8BTA	DIODE						T751	RTP115E003-V	POWER TRANSFORMER	▲
D773	RVD1SS133TA	DIODE		CN101	RJU057W007	CONNECTOR (7 P)					
D901	ISS291TA	DIODE		CN102	RJU057W007	CONNECTOR (7 P)				COMP. COMBINATION	
D903	MTZJ4R7BTA	DIODE		CN401	RJU100W07	CONNECTOR (7 P)	(MAV)				
D905	RVD1SS133TA	DIODE	(E,EB)	CN402	RJU100W07	CONNECTOR (7 P)	(MAV)	Z101	RLA6Z005M-T	AMANT/OSC	(E,EB)
D908	RVD1SS133TA	DIODE		CN501	RJU100W07	CONNECTOR (7 P)	(MAV)	Z101	RLA2Z002M-T	AMANT. COIL	(EG)
D921	RVD1SS133TA	DIODE		CN502	RJU100W04	CONNECTOR (4 P)	(MAV)	Z102	RLI2Z006M-T	AMIFT	
D923	RVD1SS133TA	DIODE		CN751	SJS305-1	CONNECTOR (3 P)		Z120	ENV17290G1R	FM TUNER PACK	
D924	MTZJ3R9ATA	DIODE		CN752	RJS1A6603	CONNECTOR (3P)		Z751	BRZV10V511CS	ZNR	▲
D925	RVD1SS133TA	DIODE		CN771	SJT3213	CONNECTOR (2 P)		Z891	RCDSFS4242N	REMOTE SENSOR	
D929	LN846RPH	DIODE		CN901	RJU003K008M1	CONNECTOR (8 P)					
D1001	MTZJ10CTA	DIODE	▲	CN902	RJU003K008M1	CONNECTOR (8 P)				CERAMIC FILTERS	
		VARIABLE RESISTORS		CN903	RJU003K008M1	CONNECTOR (8 P)					
				CN904	RJU003K008M1	CONNECTOR (8 P)		CF201	RLFETNGD01L	CERAMIC FILTER	
VR501	RRV24B02B16A	VR, VOLUME	(MAV)	CN905	RJU003K008M1	CONNECTOR (8 P)		CF202	RLFETMGD01L	CERAMIC FILTER	
VR502	EVJ02QF01G15	VR, BALANCE		CP101	RJT057W007-1	CONNECTOR (7 P)		CF901	RVBCST4R00MT	CERAMIC OSCILLATOR	
VR511	EVJYA1F01C15	VR, BASS		CP102	RJT057W007-1	CONNECTOR (7 P)		CF902	RSXZ456KM07M	CERAMIC OSCILLATOR	
VR512	EVJYA1F01C15	VR, TREBLE		CP401	RJT100W07	CONNECTOR (7 P)	(MAV)	CF105	EF0EC8004T4	CERAMIC OSCILLATOR	
				CP402	RJT100W07	CONNECTOR (7 P)	(MAV)				
				CP501	RJT100W07	CONNECTOR (7 P)	(MAV)			OSCILLATORS	
		SWITCHES		CP502	RJT100W04	CONNECTOR (4 P)	(MAV)				
				CP901	RJT003K008M1	CONNECTOR (8 P)		X101	RSXZ456KM07M	CERAMIC OSCILLATOR	
S946	EVQ21405R	SW, POWER		CP902	RJT003K008M1	CONNECTOR (8 P)		X102	RLFDGTD01I	FM REZONATOR	
S947	EVQ21405R	SW, PHONO		CP903	RJT003K008M1	CONNECTOR (8 P)		X103	SVQ49U72ZT-S	CRYSTAL OSCILLATOR	
S948	EVQ21405R	SW, MUTING		CP904	RJT003K008M1	CONNECTOR (8 P)					
S950	EVQ21405R	SW, FM AUTO/MONO		CP905	RJT003K008M1	CONNECTOR (8 P)				DISPLAY TUBE	
S951	EVQ21405R	SW, BAND									
S952	EVQ21405R	SW, TUNING DOWN				COILS TRANSFORMERS		FL901	RSL0213-F	FL DISPLAY	(MAV)
S953	EVQ21405R	SW, TUNING UP									
S954	EVQ21405R	SW, MEMORY		L101	ELESNR68MA	CHOKE COIL	(E,EB)			RELAYS	
S955	EVQ21405R	SW, SLEEP		L101	ELESN1R0MA	CHOKE COIL	(EG)				
S956	EVQ21405R	SW, PRESET DOWN		L103	ELEXTR47MA9	CHOKE COIL		RL601	RSY0013M-0	24V RELAY	
S957	EVQ21405R	SW, PRESET UP		L105	RLQZB822KT-D	TAPING COIL		RL602	RSY0013M-0	24V RELAY	
S960	EVQ21405R	SW, TUNER		L106	RLQZB822KT-D	TAPING COIL		RL751	RSY0019M-0	12V TV-5 RELAY	▲
S961	EVQ21405R	SW, CD		L151	SLM1B10-1M	COIL					
S962	EVQ21405R	SW, TAPE		L191	ELESNR68MA	CHOKE COIL	(E,EB)				
S963	EVQ21405R	SW, TV/VCR2		L191	ELESNR56MA	CHOKE COIL	(EG)				

RefNo.	PartNo.	PartName & Description	Remarks	RefNo.	PartNo.	PartName & Description	Remarks	RefNo.	PartNo.	PartName & Description	Remarks
		EARTH TERMINAL		JK351	SJF3069-3N	JK, RCA PIN					
				JK401	SJF3068-7N	JK, PHONO				ACCESSORIES	
E401	SNE1004-2	EARTH TERMINAL		JK402	SJF3069N	JK, CD					
E601	SNE1004-2	EARTH TERMINAL		JK403	SJF3069N	JK, TAPE/DCC		A1	RAK-SA612WHP	REMOTE CONTROL	[MAV]
				JK404	SJF3069N	JK, VCR2 IN		A1-1	RKK0020	BATTY COVER (R C)	
		FUSES		JK405	SJFD7	JK, FM MULTI OUT		A2	RSA0010	AM LOOP ANT	
				JK601	RJH5601	JK, SP. TERMINAL		A3	RJA0019-2A	AC CORD (SF)	(E,EG)▲
F1	XBA2C16TB0	FUSE	▲	JK602	RJR0054	JK, SP. TERMINAL		A3	VJA0733	AC-CORD [VRD] (SF)	(EB)▲
		FUSE HOLDERS		JK791	SJS9236	JK, AC INLET	▲	A4	RSA0007	FM ANTENA	
				HP601	RJ163TS01	HEADPHONES JACK		A5	RFKSEX300EK	INSTR MNL ASS'Y	[MAV](E)
FC701	RJR0169T	FUSE HOLDER	[M]			PACKING MATERIALS		A5	RFKSEX300EBK	INSTR MNL ASS'Y	[MAV](EB)
FC702	RJR0169T	FUSE HOLDER	[M]					A5	RFKSEX300EGK	INSTR MNL ASS'Y	[MAV](EG)
		JACKS						A6	SJP9009	ANT ADAPTER	(EB)▲
JK101	RJH4202	JK, ANT TERMINAL		P1	SPSD152	ACCESSORY BOX					
				P2	RPG2992	PACKING CASE	[MAV]				
				P3	RPN0865	POLYFOAM	[M]				
				P4	RPF0005	MIRAMAT SHEET	[M]				

■ Packaging

P1 (SPSD152) : ACCESSORY BOX

A1 (RAK-SA612WHP)	: REMOTE CONTROL UNIT
A2 (RSA0010)	: AM LOOP ANT
A3 (RJA0019-2A ... E,EG)	: AC CORD
A3 (VJA0733 ... EB)	: AC CORD
A4 (RSA0007)	: FM ANT
A5 (RFKSEX300EK ... E)	: INSTRUCTION MANUAL ASS'Y
A5 (RFKSEX300EBK ... EB)	: INSTRUCTION MANUAL ASS'Y
A5 (RFKSEX300EGK ... EG)	: INSTRUCTION MANUAL ASS'Y
A6 (SJP9009 ... EB)	: ANTENNA ADAPTER

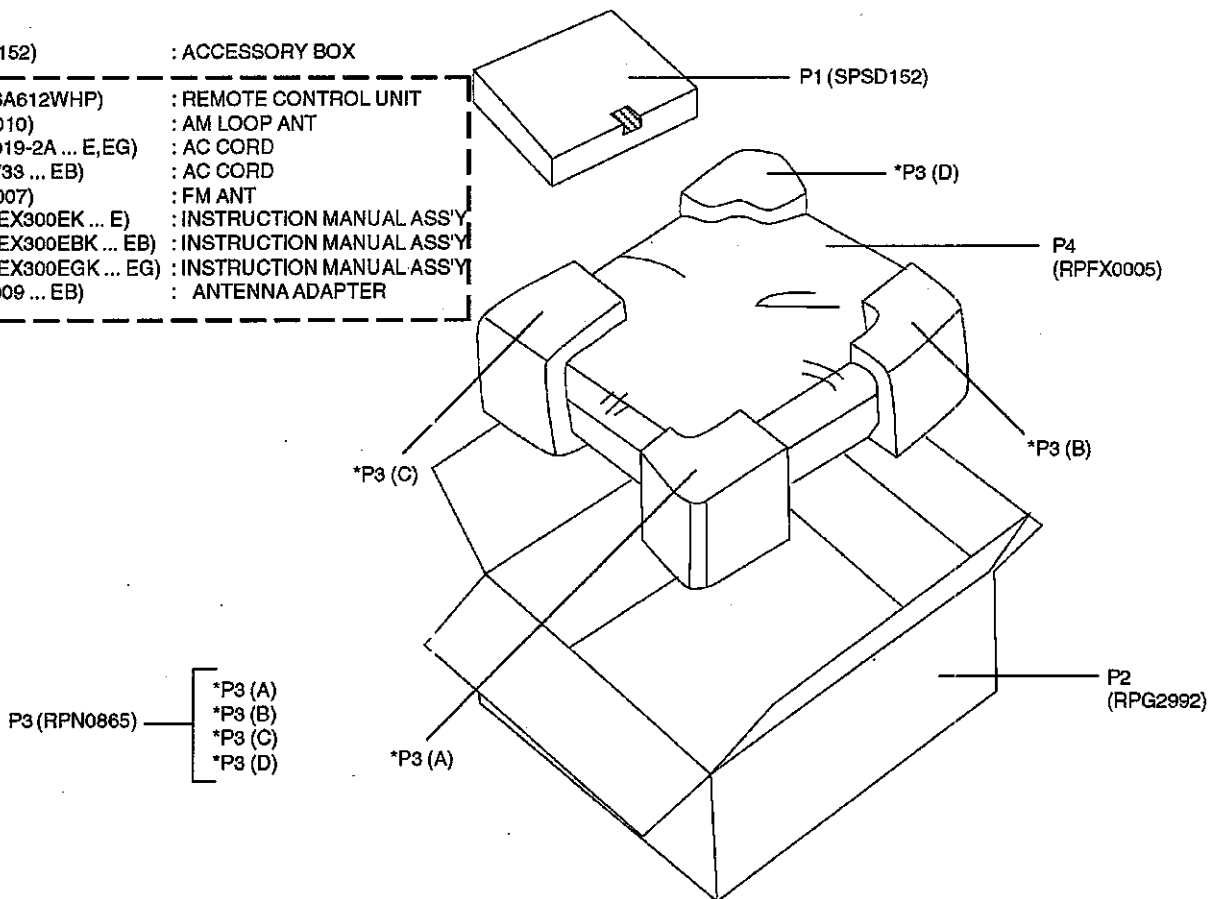

Resistors & Capacitors

Notes : • Important safety notice:

Components identified by Δ mark have special characteristics important for safety.

Furthermore, special parts which have purposes of fire-retardant (resistors), high-quality sound (capacitors), low-noise (resistors), etc. are used. When replacing any of components, be sure to use only manufacturer's specified parts shown in the parts list.

- Capacitor values are in microfarad (μ F) unless specified otherwise, P=Pico-farads (pF) F=Farads (F)
- Resistors values are in ohms, unless specified otherwise, 1K=1,000(OHM), 1M=1,000K(OHM)
- [M] in Remarks column indicates parts that are supplied by MESA.
- [MAV] in Remarks column indicates parts that are supplied by MAV.

Ref.No.	Part.No.	Values & Remarks	Ref.No.	Part.No.	Values & Remarks	Ref.No.	Part.No.	Values & Remarks	Ref.No.	Part.No.	Values & Remarks
	RESISTORS		R146	ERDS2TJ102T	1K 1/4W(EB)	R417	ERDS2TJ473T	47K 1/4W	R515	ERDS2TJ474T	470K 1/4W
			R146	ERDS2TJ561T	560 1/4W(EG)	R418	ERDS2TJ473T	47K 1/4W	R516	ERDS2TJ474T	470K 1/4W
			R147	ERDS2TJ474T	470K 1/4W	R419	ERDS2TJ104T	100K 1/4W	R517	ERDS2TJ332T	3.3K 1/4W
R103	ERDS2TJ101T	100 1/4W	R148	ERDS2TJ474T	470K 1/4W	R420	ERDS2TJ104T	100K 1/4W	R518	ERDS2TJ332T	3.3K 1/4W
R104	ERDS2TJ102T	1K 1/4W	R149	ERDS2TJ680T	68 1/4W	R421	ERDS2TJ104T	100K 1/4W	R519	ERDS2TJ222T	2.2K 1/4W
R105	ERDS2TJ471T	470 1/4W	R171	ERDS2TJ102T	1K 1/4W	R422	ERDS2TJ104T	100K 1/4W	R520	ERDS2TJ222T	2.2K 1/4W
R106	ERDS2TJ224T	220K 1/4W	R172	ERDS2TJ102T	1K 1/4W	R423	ERDS2TJ102T	1K 1/4W	R521	ERDS2TJ223T	22K 1/4W
R107	ERDS2TJ471T	470 1/4W	R173	ERDS2TJ471T	470 1/4W	R424	ERDS2TJ102T	1K 1/4W	R522	ERDS2TJ223T	22K 1/4W
R110	ERDS2TJ102T	1K 1/4W	R175	ERDS2TJ102T	1K 1/4W	R425	ERDS2TJ103T	10K 1/4W	R523	ERDS2TJ392T	3.9K 1/4W
R112	ERDS2TJ104T	100K 1/4W	R176	ERDS2TJ391T	390 1/4W	R426	ERDS2TJ103T	10K 1/4W	R524	ERDS2TJ392T	3.9K 1/4W
R113	ERDS2TJ103T	10K 1/4W	R181	ERDS2TJ332T	3.3K 1/4W	R427	ERDS2TJ103T	10K 1/4W	R525	ERDS2TJ222T	2.2K 1/4W
R114	ERDS2TJ562T	5.6K 1/4W	R191	ERDS2TJ103T	10K 1/4W	R440	ERDS1FVJ820T	82 1/2W Δ	R526	ERDS2TJ222T	2.2K 1/4W
R115	ERDS2TJ561T	560 1/4W	R192	ERDS2TJ122T	1.2K 1/4W	R441	ERDS2TJ473T	47K 1/4W	R527	ERDS2TJ122T	1.2K 1/4W
R116	ERDS2TJ102T	1K 1/4W	R193	ERDS2TJ182T	1.8K 1/4W	R442	ERDS2TJ473T	47K 1/4W	R528	ERDS2TJ122T	1.2K 1/4W
R117	ERDS2TJ473T	47K 1/4W	R194	ERDS2TJ122T	1.2K 1/4W	R443	ERDS2TJ330T	33 1/4W	R529	ERDS2TJ273T	27K 1/4W
R118	ERDS2TJ562T	5.6K 1/4W	R195	ERDS2TJ222T	2.2K 1/4W	R451	ERDS2TJ224T	220K 1/4W	R530	ERDS2TJ273T	27K 1/4W
R119	ERDS2TJ183T	18K 1/4W	R301	ERDS2TJ680T	68 1/4W	R452	ERDS2TJ224T	220K 1/4W	R531	ERDS2TJ332T	3.3K 1/4W
R120	ERDS2TJ473T	47K 1/4W	R302	ERDS2TJ680T	68 1/4W	R453	ERDS2TJ391T	390 1/4W	R532	ERDS2TJ332T	3.3K 1/4W
R121	ERDS2TJ332T	3.3K 1/4W	R359	ERDS2TJ750T	75 1/4W	R454	ERDS2TJ391T	390 1/4W	R533	ERDS2TJ103T	10K 1/4W
R122	ERDS2TJ272T	2.7K 1/4W	R362	ERDS2TJ750T	75 1/4W	R455	ERDS2TJ563T	56K 1/4W	R534	ERDS2TJ103T	10K 1/4W
R124	ERDS2TJ271T	270 1/4W	R367	ERDS2TJ102T	1K 1/4W	R456	ERDS2TJ563T	56K 1/4W	R543	ERDS2TJ102T	1K 1/4W
R125	ERDS2TJ472T	4.7K 1/4W	R368	ERDS2TJ102T	1K 1/4W	R457	ERDS2TJ271T	270 1/4W	R544	ERDS2TJ102T	1K 1/4W
R126	ERDS2TJ472T	4.7K 1/4W	R369	ERDS2TJ182T	1.8K 1/4W	R458	ERDS2TJ271T	270 1/4W	R545	ERDS2TJ824T	820K 1/4W
R127	ERDS2TJ103T	10K 1/4W	R370	ERDS2TJ182T	1.8K 1/4W	R459	ERDS2TJ680T	68 1/4W	R546	ERDS2TJ102T	1K 1/4W
R128	ERDS2TJ820T	82 1/4W	R371	ERD2FCVG220T	22 1/4W	R460	ERDS2TJ680T	68 1/4W	R551	ERDS2TJ102T	1K 1/4W
R129	ERDS2TJ473T	47K 1/4W	R372	ERD2FCVG220T	22 1/4W	R461	ERDS2TJ184T	180K 1/4W	R552	ERDS2TJ102T	1K 1/4W
R130	ERDS2TJ102T	1K 1/4W	R373	ERDS2TJ103T	10K 1/4W	R462	ERDS2TJ184T	180K 1/4W	R553	ERDS2TJ104T	100K 1/4W
R131	ERDS2TJ102T	1K 1/4W	R374	ERDS2TJ103T	10K 1/4W	R463	ERDS2TJ123T	12K 1/4W	R554	ERDS2TJ104T	100K 1/4W
R132	ERDS2TJ103T	10K 1/4W	R401	ERDS2TJ102T	1K 1/4W	R464	ERDS2TJ123T	12K 1/4W	R555	ERDS2TJ223T	22K 1/4W
R133	ERDS2TJ102T	1K 1/4W	R402	ERDS2TJ102T	1K 1/4W	R465	ERDS2TJ563T	56K 1/4W	R556	ERDS2TJ223T	22K 1/4W
R134	ERDS2TJ102T	1K 1/4W	R405	ERDS2TJ102T	1K 1/4W	R466	ERDS2TJ563T	56K 1/4W	R557	ERDS2TJ681T	680 1/4W
R135	ERDS2TJ102T	1K 1/4W	R406	ERDS2TJ102T	1K 1/4W	R467	ERDS2TJ102T	1K 1/4W	R558	ERDS2TJ102T	1K 1/4W
R136	ERDS2TJ102T	1K 1/4W	R407	ERDS2TJ102T	1K 1/4W	R468	ERDS2TJ102T	1K 1/4W	R559	ERDS2TJ104T	100K 1/4W
R137	ERDS2TJ102T	1K 1/4W	R408	ERDS2TJ102T	1K 1/4W	R469	ERDS2TJ102T	1K 1/4W	R560	ERDS2TJ104T	100K 1/4W
R139	ERDS2TJ272T	2.7K 1/4W	R409	ERDS2TJ102T	1K 1/4W	R470	ERDS2TJ102T	1K 1/4W	R561	ERDS2TJ822T	8.2K 1/4W
R140	ERDS2TJ272T	2.7K 1/4W	R410	ERDS2TJ102T	1K 1/4W	R501	ERDS2TJ222T	2.2K 1/4W	R562	ERDS2TJ822T	8.2K 1/4W
R141	ERDS2TJ102T	1K 1/4W	R411	ERDS2TJ102T	1K 1/4W	R502	ERDS2TJ222T	2.2K 1/4W	R563	ERDS2TJ332T	3.3K 1/4W
R142	ERDS2TJ102T	1K 1/4W	R412	ERDS2TJ102T	1K 1/4W	R508	ERDS1FVJ2R2T	2.2 1/2W Δ	R565	ERDS2TJ102T	1K 1/4W
R143	ERDS2TJ222T	2.2K 1/4W	R413	ERDS2TJ102T	1K 1/4W	R511	ERDS2TJ471T	470 1/4W	R566	ERDS2TJ102T	1K 1/4W
R144	ERDS2TJ222T	2.2K 1/4W	R414	ERDS2TJ102T	1K 1/4W	R512	ERDS2TJ471T	470 1/4W	R595	ERDS2TJ122T	1.2K 1/4W
R145	ERDS2TJ102T	1K 1/4W(EB)	R415	ERDS2TJ102T	1K 1/4W	R513	ERDS2TJ474T	470K 1/4W	R596	ERDS2TJ122T	1.2K 1/4W
R145	ERDS2TJ561T	560 1/4W(EG)	R416	ERDS2TJ102T	1K 1/4W	R514	ERDS2TJ474T	470K 1/4W	R601	ERDS2TJ102T	1K 1/4W

Ref No.	Part No.	Values & Remarks	Ref No.	Part No.	Values & Remarks	Ref No.	Part No.	Values & Remarks	Ref No.	Part No.	Values & Remarks
C2	ECBKR1H473ZF5	0.047 50V	C148	ECBT1C103NS5	0.01 16V	C440	ECBT1E103ZF5	0.01 25V	C551	ECEA1HKA3R3B	3.3 50V
C101	ECBT1C103NS5	0.01 16V	C149	ECBT1C103NS5	0.01 16V	C451	ECEA1VU4R7B	4.7 10V	C552	ECEA1HKA3R3B	3.3 50V
C103	ECBT1C103NS5	0.01 16V	C150	ECBT1H104ZF5	0.1 50V	C452	ECEA1VU4R7B	4.7 10V	C553	ECBT1H101KB5	100P 50V
C104	ECBT1H102KB5	1000P 50V	C172	ECBT1H331KB5	330P 50V	C453	ECBT1H100JC5	10P 50V	C554	ECBT1H101KB5	100P 50V
C105	ECBT1H470J5	47P 50V	C173	ECEA1CKA220B	22 16V	C454	ECBT1H100JC5	10P 50V	C555	ECBT1H221KB5	220P 50V
C106	ECBT1C103NS5	0.01 16V	C174	ECEA1CKA101B	100 16V	C455	ECBT1H102KB5	1000P 50V	C556	ECBT1H221KB5	220P 50V
C107	ECBT1H473ZF5	0.047 50V	C175	ECBT1C103NS5	0.01 16V	C456	ECBT1H102KB5	1000P 50V	C557	ECBT1E103ZF5	0.01 25V
C108	ECBT1H100JC5	10P 50V	C176	ECBT1C103NS5	0.01 16V	C457	ECEA1AU330B	33 10V	C558	ECBT1E103ZF5	0.01 25V
C108	ECBT1H8R2KC5	8.2P 50V EG	C181	ECBT1H471KB5	470P 50V	C458	ECEA1AU330B	33 10V	C559	ECEA1CKA100B	10 16V
C109	ECBT1C103NS5	0.01 16V	C196	ECBT1H102KB5	1000P 50V	C459	ECFR1E223KR	0.022 25V	C560	ECEA1CKA100B	10 16V
C110	ECBT1C103NS5	0.01 16V	C330	ECBT1H470J5	47P 50V	C460	ECFR1E223KR	0.022 25V	C561	ECEA1HU3R3B	3.3 50V
C111	ECEA1EKA4R7B	4.7 25V	C331	ECBT1H470J5	47P 50V	C461	ECFR1E682KR	6800P 25V	C562	ECEA1HU3R3B	3.3 50V
C112	ECBT1C103NS5	0.01 16V	C351	ECEA0U101B	100 6.3V	C462	ECFR1E682KR	6800P 25V	C563	ECBT1E103ZF5	0.01 25V
C113	ECBT1H102KB5	1000P 50V	C352	ECEA0U101B	100 6.3V	C463	ECEA1VU4R7B	4.7 10V	C595	ECBT1H221KB5	220P 50V
C114	ECEA1HKA3R3B	3.3 50V	C354	ECBT1E103ZF5	0.01 25V	C464	ECEA1VU4R7B	4.7 10V	C601	ECEA1HKN3R3B	3.3 50V
C115	ECEA1EKA4R7B	4.7 25V	C355	ECBT1E103ZF5	0.01 25V	C465	ECBT1E103ZF5	0.01 25V	C602	ECEA1HKN3R3B	3.3 50V
C116	ECBT1C822MS5	8200P 16V	C357	ECBT1E103ZF5	0.01 25V	C466	ECBT1E103ZF5	0.01 25V	C603	ECBT1H681KB5	680P 50V
C117	ECQB1H471JF3	470P 50V	C358	ECBT1E103ZF5	0.01 25V	C469	ECBT1H181KB5	180P 50V	C604	ECBT1H681KB5	680P 50V
C118	ECQB1H103JF3	0.01 50V	C373	ECEA1CU470B	47 16V	C470	ECBT1H181KB5	180P 50V	C605	ECEA1JU220B	22 63V
C119	ECQB1H103JF3	0.01 50V	C374	ECEA1CU470B	47 16V	C503	ECEA0JKA101B	100 6.3V	C606	ECEA1JU220B	22 63V
C120	ECEA1HKA010B	1 50V	C401	ECEA1VU4R7B	4.7 10V	C504	ECEA0JKA101B	100 6.3V	C607	ECCR1H120KCS	12P 50V
C121	ECEA1HKA010B	1 50V	C402	ECEA1VU4R7B	4.7 10V	C505	ECFR1C104MR	0.1 16V	C608	ECCR1H120KCS	12P 50V
C122	ECEA1HKA2R2B	2.2 50V	C403	ECBT1E103ZF5	0.01 25V	C506	ECFR1C104MR	0.1 16V	C609	ECBT1H221KB5	220P 50V
C123	ECEA1HKA010B	1 50V	C404	ECBT1E103ZF5	0.01 25V	C511	ECEA1HKA3R3B	3.3 50V	C610	ECBT1H221KB5	220P 50V
C124	ECBT1H102KB5	1000P 50V	C405	ECBT1H101KB5	100P 50V	C512	ECEA1HKA3R3B	3.3 50V	C611	ECQV1H473JZ3	0.047 50V
C125	ECBT1H150JC5	15P 50V	C406	ECBT1H101KB5	100P 50V	C513	ECBT1H150J5	15P 50V	C612	ECQV1H473JZ3	0.047 50V
C126	ECBT1H104ZF5	0.1 50V	C409	ECEA1CU220B	22 16V	C514	ECBT1H150J5	15P 50V	C613	ECEA1CU470B	47 16V
C127	ECEA1CKA220B	22 16V	C410	ECEA1CU220B	22 16V	C515	ECBT1H221KB5	220P 50V	C615	ECBT1H101KB5	100P 50V
C128	ECBT1C103NS5	0.01 16V	C411	ECBT1H101KB5	100P 50V	C516	ECBT1H221KB5	220P 50V	C617	ECBKR1H03ZF5	0.01 50V
C129	ECEA0JKA101B	100 6.3V	C412	ECBT1H101KB5	100P 50V	C517	ECBT1H330J5	33P 50V	C618	ECEA2AU100B	10 100V
C130	ECEA0JKA101B	100 6.3V	C413	ECEA1CKA100B	10 16V	C518	ECBT1H330J5	33P 50V	C631	ECBKR1H223ZF5	0.022 50V
C131	ECBT1C103NS5	0.01 16V	C414	ECEA1CKA100B	10 16V	C519	ECEA1VKA4R7B	4.7 10V	C632	ECBKR1H223ZF5	0.022 50V
C132	ECBT1H102KB5	1000P 50V	C415	ECBT1E103ZF5	0.01 25V	C520	ECEA1VKA4R7B	4.7 10V	C633	ECBT1H101KB5	100P 50V
C133	ECBT1H150JC5	15P 50V	C416	ECBT1E103ZF5	0.01 25V	C521	ECEA1VKA4R7B	4.7 10V	C635	ECBKR1H223ZF5	0.022 50V
C134	ECBT1H180JC5	18P 50V	C417	ECBT1H101KB5	100P 50V	C522	ECEA1VKA4R7B	4.7 10V	C636	ECBKR1H223ZF5	0.022 50V
C135	ECBT1C103MS5	0.01 16V	C418	ECBT1H101KB5	100P 50V	C523	ECFR1E123KR	0.012 25V	C637	ECBKR1H223ZF5	0.022 50V
C136	ECBT1C103MS5	0.01 16V	C419	ECBT1H331KB5	330P 50V	C524	ECFR1E123KR	0.012 25V	C651	ECEA1HKN3R3B	3.3 50V
C137	ECBT1H561KB5	560P 50V	C420	ECBT1H331KB5	330P 50V	C525	ECQV1H683JZ3	0.068 50V	C652	ECEA1HKN3R3B	3.3 50V
C138	ECBT1H561KB5	560P 50V	C421	ECBT1H331KB5	330P 50V	C526	ECQV1H683JZ3	0.068 50V	C653	ECBT1H681KB5	680P 50V
C139	ECQB1H682JF3	6800P 50V	C422	ECBT1H331KB5	330P 50V	C527	ECBT1C562KR5	5600P 16V	C654	ECBT1H681KB5	680P 50V
C140	ECQB1H682JF3	6800P 50V	C423	ECBT1H101KB5	100P 50V	C528	ECBT1C562KR5	5600P 16V	C655	ECEA1JU220B	22 63V
C141	ECEA1HKA010B	1 50V	C424	ECBT1H101KB5	100P 50V	C529	ECQB1H273JF3	0.027 50V	C656	ECEA1JU220B	22 63V
C142	ECEA1HKA010B	1 50V	C425	ECBT1H101KB5	100P 50V	C530	ECQB1H273JF3	0.027 50V	C657	ECCR1H120KCS	12P 50V
C143	ECEA1HKA010B	1 50V	C426	ECBT1H101KB5	100P 50V	C531	ECBT1E103ZF5	0.01 25V	C658	ECCR1H120KCS	12P 50V
C144	ECEA1HKA010B	1 50V	C427	ECBT1H221KB5	220P 50V	C532	ECBT1E103ZF5	0.01 25V	C659	ECBT1H221KB5	220P 50V
C145	ECBT1H220JC5	22P 50V	C428	ECBT1H221KB5	220P 50V	C533	ECEA1CKA100B	10 16V	C660	ECBT1H221KB5	220P 50V
C146	ECBT1H331KB5	330P 50V	C431	ECEA1CKA100B	10 16V	C534	ECEA1CKA100B	10 16V	C661	ECQV1H473JZ3	0.047 50V
C147	ECBT1H102KB5	1000P 50V	C432	ECEA1CKA100B	10 16V	C536	ECBT1E103ZF5	0.01 25V	C662	ECQV1H473JZ3	0.047 50V

RefNo	PartNo.	Values & Remarks	RefNo	PartNo.	Values & Remarks	RefNo	PartNo.	Values & Remarks	RefNo	PartNo.	Values & Remarks
C667	ECKR1H103ZF5	0.01 50V	C922	ECBT1H331KB5	330P 50V	C1034	BCQV1H474JZ3	0.47 50V			
C668	ECEA2AU100B	10 100V	C923	ECBT1H331KB5	330P 50V	C1035	BCBT1H681KB5	680P 50V			
C681	ECEA1HN100SB	10 50V	C924	ECBT1H331KB5	330P 50V	C1036	ECBT1H101KB5	100P 50V			
C682	ECEA1HN100SB	10 50V	C925	ECBT1H331KB5	330P 50V	C1037	ECBT1H101KB5	100P 50V			
C683	ECBT1C332KR5	3300P 16V	C926	ECBT1H331KB5	330P 50V	C1038	ECBT1H101KB5	100P 50V			
C684	ECBT1C332KR5	3300P 16V	C927	ECBT1H331KB5	330P 50V	C1039	ECEA1CU101B	100 16V			
C685	ECBT1E103ZF5	0.01 25V	C928	ECBT1H331KB5	330P 50V	C1040	ECEA1CKA100B	10 16V			
C701	ECBT1E103ZF5	0.01 25V	C929	ECBT1H331KB5	330P 50V	C1041	ECBT1E103ZF5	0.01 25V			
C702	ECQE2104KF3	4K 250V	C930	ECBT1H331KB5	330P 50V	C1051	ECEA1HKA2R2B	2.2 50V			
C703	ECOS1HP682BB Δ	6800P 50V(MAV)	C931	ECBT1H102KB5	1000P 50V	C1052	ECEA1HKA010B	1 50V			
C704	ECOS1HP682BB Δ	6800P 50V(MAV)	C934	ECBT1H101KB5	100P 50V	C1053	ECEA1HU3R3B	3.3 50V			
C705	ECBT1H101KB5	100P 50V	C935	ECBT1E103ZF5	0.01 25V	C1054	ECEA0JU221B	220 6.3V			
C707	ECA1VM101B	100 10V	C936	ECBT1H101KB5	100P 50V	C1055	ECEA1HKA010B	1 50V			
C708	ECKR1H103ZF5	0.01 50V	C944	ECBT1H101KB5	100P 50V	C1056	ECFR1E563KR	0.056 25V			
C709	ECEA1CU330B	33 16V	C947	ECBT1E103ZF5	0.01 25V	C1057	ECFR1E152KR	1500P 25V			
C710	ECBT1E103ZF5	0.01 25V	C948	ECBT1E103ZF5	0.01 25V	C1058	ECFR1E563KR	0.056 25V			
C711	ECKR1H103ZF5	0.01 50V	C1001	ECEA1HKA010B	1 50V	C1059	ECEA1CU101B	100 16V			
C712	ECEA1HKA100B	10 50V	C1002	ECEA1HKA010B	1 50V	C1060	ECBT1E223ZF5	0.022 25V			
C713	ECKR1H103ZF5	0.01 50V	C1003	ECEA1HU3R3B	3.3 50V	C1062	ECBT1E223ZF5	0.022 25V			
C714	ECEA1CU470B	47 16V	C1004	ECEA1HU3R3B	3.3 50V	C1063	ECEA1CU101B	100 16V			
C716	ECEA1CKA100B	10 16V	C1005	ECEA1HKA010B	1 50V	C1065	ECBT1H681KB5	680P 50V			
C751	ECKWRS102MBC Δ	000140VAC(MAV)	C1007	ECFR1E223KR	0.022 25V	C1067	ECBT1C152KR5	1500P 16V			
C752	ECKR1H103ZF5	0.01 50V	C1008	ECFR1E473KR	0.047 25V	C1068	ECBT1C152KR5	1500P 16V			
C753	ECA1EM102B	1000 25V Δ	C1009	ECEA0JU221B	220 6.3V	C1151	ECEA1HKA010B	1 50V			
C754	ECBT1E103ZF5	0.01 25V	C1010	ECEA1CKA100B	10 16V	C1152	ECFR1C683KR	0.068 16V			
C755	ECEA1CKA470B	47 16V	C1011	ECEA1CKA100B	10 16V	C1153	ECFR1C773KR	0.027 16V			
C757	ECEA1AKA101B	100 10V	C1012	ECEA1CKA100B	10 16V	C1154	ECEA1VU4R7B	4.7 10V			
C771	ECEA1HKA2R2B	2.2 50V	C1013	ECEA1CKA100B	10 16V	C1155	ECBT1E103ZF5	0.01 25V			
C772	ECEA1CKA100B	10 16V	C1014	ECEA0JU221B	220 6.3V	C1156	ECBT1E103ZF5	0.01 25V			
C773	ECBT1E223ZF5	0.022 25V	C1015	ECQV1H104JZ3	0.1 50V	C1157	ECBT1E103ZF5	0.01 25V			
C774	ECEA0JU221B	220 6.3V	C1016	ECQV1H104JZ3	0.1 50V	C1158	ECBT1H101KB5	100P 50V			
C901	ECEA0JU102B	1000 6.3V	C1017	ECEA1HKAR47B	0.47 50V	C1159	ECEA1CU101B	100 16V			
C902	ECBT1E223ZF5	0.022 25V	C1018	ECEA1VU4R7B	4.7 10V						
C903	ECBT1E103ZF5	0.01 25V	C1019	ECEA1HKAR47B	0.47 50V						
C904	ECEA0JU102B	1000 6.3V	C1020	ECEA1VU4R7B	4.7 10V						
C906	ECEA0JKA101B	100 6.3V	C1021	ECEA1HKAR15B	0.15 50V						
C908	ECBT1E103ZF5	0.01 25V	C1022	ECEA1HU3R3B	3.3 50V						
C909	ECEA1HKA220B	22 50V	C1023	ECQV1H154JZ3	0.15 50V						
C910	ECEA1HKA220B	22 50V	C1024	ECQV1H154JZ3	0.15 50V						
C911	ECEA1HKA220B	22 50V	C1025	ECEA1HU3R3B	3.3 50V						
C912	ECEA1HKA220B	22 50V	C1026	ECEA1HKAR15B	0.15 50V						
C913	ECEA1VKA100B	10 10V	C1027	ECEA1VU4R7B	4.7 10V						
C914	ECEA1VKA100B	10 10V	C1028	ECEA1HKAR47B	0.47 50V						
C916	ECEA1HKA010B	1 50V	C1029	ECEA1VU4R7B	4.7 10V						
C917	ECEA1HKAR47B	0.47 50V	C1030	ECEA1HKAR47B	0.47 50V						
C918	ECEA0JKA221B	220 6.3V	C1031	ECQV1H104JZ3	0.1 50V						
C920	ECEA1HKA010B	1 50V	C1032	ECQV1H104JZ3	0.1 50V						
C921	ECBT1H331KB5	330P 50V	C1033	ECEA0JKA470B	47 6.3V						