

# SKYRC

# MC3000

MULTI-CHEMISTRY

## Universal Battery Charger & Analyzer

NiMH / NiCd / NiZn / Eneloop / Lithium-Ion / Lilo4.35 / LiFePO4

# SKYRC



# INSTRUCTION MANUAL

Manufactured by  
SKYRC TECHNOLOGY CO., LTD.  
www.skyrc.com



© 2015 SkyRC Technology Co., Ltd. All Rights Reserved.

Version 1.0

7504-0680-01

INTRODUCTION.....	01
WARNING AND SAFETY PRECAUTIONS.....	03
QUICK START GUIDE.....	04
BATTERY KNOWLEDGE.....	10
BATTERY VOLTAGES.....	11
TOTAL OVERVIEW.....	12
GLOBAL SETUP VIEW.....	14
SLOT PROGRAMMING VIEW.....	17
SLOT OPERATION VIEW.....	24
DIAGRAM DRAWING VIEW.....	27
USER CALIBRATION.....	28
PC LINK.....	30
FIRMWARE UPDATE.....	31
BLUETOOTH APP.....	32
ERROR MESSAGE.....	35
FAQ'S.....	36
GLOSSARY.....	37
SPECIFICATIONS.....	38
PACKAGE CONTENTS.....	39
CONFORMITY DECLARATION.....	40
LIABILITY EXCLUSION.....	41
WARRANTY AND SERVICE.....	41

## Welcome

Charging batteries is usually a primitive, boring task. Can't fool your friends, it still is. In fact, this charger merely knows three elementary routines: charge, discharge, rest. However ... refining, combining, and repeating them in impressive cycles will make you feel dominant and superior! We believe that operating the device will bring some fun and satisfaction to an otherwise mundane activity: charging one's empty batteries. The MC3000 may be the most joyful not so compact 4-bay universal round battery charger in the world. Maybe. The creation of this product arose from the desire to finally have a charger as versatile, accurate and powerful as a SKYRC hobby charger but tailored to a sweet battery tray for cylindrical single cell batteries; no more hassle with battery holders, fiddly wiring, clamps or similar DIY solutions. With the agreeable set of options per program, or by sequencing several such programs, the MC3000 is capable of mimicking virtually any operation mode recommended by leading battery manufacturers or employed by other commercial chargers.

## Features

The charger supports all common round battery sizes and chemistries in 4 independent slots, has numerous safety mechanisms to protect user, device, and batteries from harm, offers maximum charge rate of 3A/slot, true constant current for both charging and discharging, analyzing capability, PC & Bluetooth 4.0 monitor & control, user calibration, high accuracy and an intuitive user interface, while the updatable firmware ensures flexibility to respond to user demands and future market or technology changes.

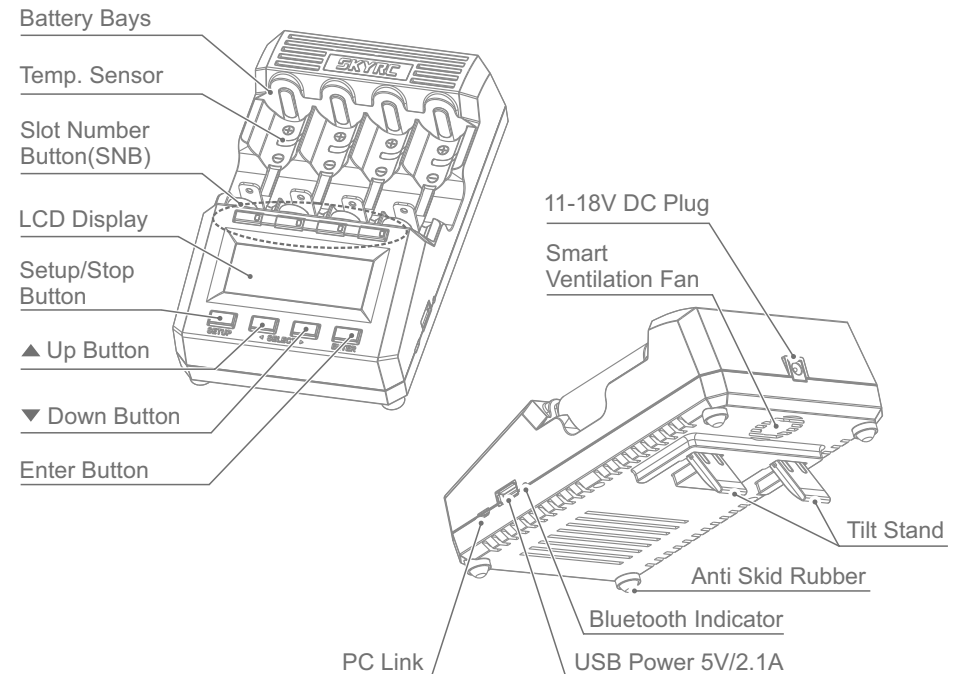

## User Interface

The UI can be switched between *Dummy*, *Simple* and *Advanced* menu modes. The advanced menu lets the user control every single technical parameter of the operation mode whereas a simpler mode with less options may be more convenient for quick everyday usage. The key concept behind the UI are the numbered user programs: the MC3000 comes with 30 editable programs and whenever the user is operating a slot, he/she is indeed operating a particular numbered program in that slot and therefore should be well aware of the program number itself! The 30 programs are defined globally: any ready slot can run the identical program simply by the user assigning the same program number to the slot. And that is done fast and efficiently.

## Slot Number Buttons

Integral part of the UI are the bi-color LEDs of the slot number buttons indicating one of the 6 possible operational states of a slot. An empty slot (=black SNB) is a slot with no battery in it, a ready slot (=blinking red-green SNB) is ready to start the program, a busy slot (=solid red SNB) is running a program, a finished slot (=solid green SNB) has finished a program normally. An inactive slot is an empty or ready slot, an active slot is a busy or finished slot. A blinking red SNB indicates an error, abnormal program termination, or similar. A blinking green SNB means happiness.

## Control Buttons

The STOP button at the bottom left has similar meanings in different contexts. It can mean Cancel, Discard, Abort, Quit or Exit when programming inactive slots, or Finish or Stop when operating active slots. It is also the button for accessing the device SETUP. The ENTER button at the bottom right means Enter or Save when programming inactive slots, Start for starting ready slots, or Return to the main view when operating active slots. The UP and DOWN buttons mean Up and Down, or Increase and Decrease, and are for changing program numbers, scrolling through options, selecting parameters. Changing the program number means effectively that you switched to the new program with the new program number and not only changed the number itself. For faster programming, a changed program can be saved under a new program number, or copied over to all slots at once.

## Screen

The 128x64 LCD screen features five common views which the user should be familiar with:

- The total overview (TOV) is the main view where other views automatically revert to after periods of user inactivity. In tabular format, it shows at a glance the most important bits of information about the operation of the slots. TOV is also used for displaying quick info lines or error messages, for example at abnormal program termination.
- The MC3000 has numerous explicit options with their respective parameters which the user can check or control. The more general settings are accessible through SETUP in the global setup view (GSV). They affect the operation of the entire device, not only of a single slot or program.
- In slot programming view (SPV) the user can either swiftly change the program to a different program and or edit its detailed settings. Each of the four slots is independent and can run any of the 30 global programs.
- Naturally the slot operation view (SOV) is available for active slots only, i.e. slots with an ongoing or finished program. Apart from the most basic info already given in TOV, it also shows additional quantities such as energy, power, resistance, temperature, and time.
- The diagram drawing view (DDV) provides a quick overview of the voltage graphs over time. The graphs are available and live for active slots.

## Accuracy

Under lab conditions the accuracy of the MC3000 readings will stay within the maximum achievable tolerance as stated on its spec sheet, i.e.  $\pm 1\text{mV}$  or  $\pm 1\text{mA}$ . Under typical conditions, e.g. analyzing 2-3 batteries at modest loads with no external cooling, the accuracy will reach maximum precision too. That is because the installed internal cooler and ventilation fan are still able to dissipate the heat away from the precision electronics. However, at extreme loads and conditions, 15W constant maximum discharge power on a hot summer holiday, unremoved heat can affect the accuracy to some albeit rather limited extent. Stress tests have proven that the charger can work at its operational limits without degradation but we do recommend that the user helps with extra cooling once the plastic casing gets hot to the touch.

## WARNING AND SAFETY PRECAUTIONS

- ⚠ Never leave the charger unattended when it is connected to power. If any malfunction is found, terminate the process at once and refer to the operation manual.
- ⚠ Please make sure the correct program and settings are chosen and set. Incorrect program or setting may damage the charger or cause fire or explosion.
- ⚠ Never attempt to charge primary cells such as Alkaline, Zinc-Carbon, Lithium, CR123A, CR2, or any other unsupported chemistry due to risk of explosion and fire.
- ⚠ Never charge or discharge any battery having evidence of leakage, expansion/swelling, damaged outer wrapper or case, color-change or distortion.
- ⚠ Use the original adapter and cord for power supply. To reduce the risk of damage to the power cord, always pull by connector rather than the cord. The allowable DC input voltage is 11~18V DC.
- ⚠ Do not operate the device if it appears damaged in any way.
- ⚠ Do not expose the device to direct sunlight, heating devices, open flames; avoid extreme high or extreme low ambient temperatures and sudden temperature changes.
- ⚠ Do not expose the device to rain, water, moisture, high humidity, or dust due to risk of fire and corrosion. The device should only be used at normal indoor room conditions.
- ⚠ Operate on a hard flat nice clean smooth heat-resistant nonflammable nonconductive surface in a well-ventilated area. Never place the device on a carpet, car seat, or similar. Keep all the inflammable volatile substances away from operating area.
- ⚠ Avoid mechanical vibration or shock as these may cause damage to the device.
- ⚠ Do not short-circuit slots or other parts of the device. Do not allow metal wires or other conductive material into the charger.
- ⚠ Observe polarity diagrams located on the charger. Always place the battery cells with positive tip facing the top.
- ⚠ Do not touch hot surfaces. The rechargeable batteries or the device may become hot at full load or high power charging/discharging.
- ⚠ Never block the cooling fan or the air ventilation holes at the bottom and top of the charger.

# QUICK START GUIDE

- ❗ Do not overcharge nor over discharge batteries. Recharge drained batteries as soon as possible.
- ❗ Remove all batteries and unplug the charging unit from the power source when not in use.
- ❗ Opening, disassembling, modifying, tampering with the unit may invalidate its guarantee, check warranty terms.
- ❗ Do not misuse in any way! Use for intended purpose and function only.

## QUICK START GUIDE

Read the Warning and Safety Precautions first and follow them.

### Operating Instructions

1. Proper handling suggests that all batteries be removed prior to operation.
2. First connect the 11~18V(60W or more) DC power adapter plug to the device, then plug the 110/220V AC power cable plug into the mains wall socket. In this order. The device boots up and displays the "UI Mode Selection".

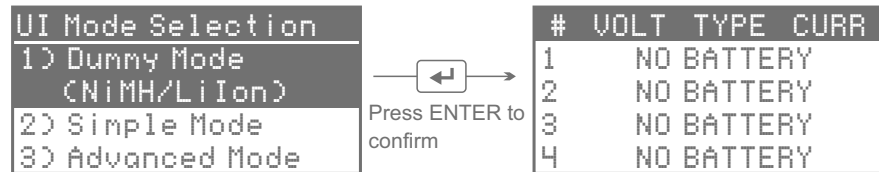

Select the UI Mode you feel more comfortable with. This page appears only once. You may switch UI Mode under SETUP menu later if desired (see 5.).  
Let's select Dummy Mode (This mode supports NiMH and Lilon only).

3. Insert round batteries in the empty slots observing correct polarity. In this particular UI Mode the battery type is detected automatically. Check if the displayed TYPE matches your battery chemistry correctly. The SNB will be blinking alternately green and red to indicate that the slot is ready. In Dummy Mode you can adjust charging current only, see next step.

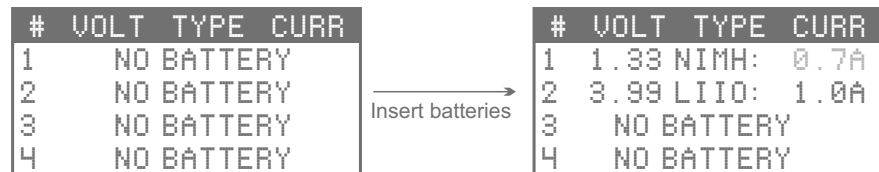

4. Press the blinking SNB. Its corresponding current value on the screen will be blinking to indicate that the charging current can be adjusted now. Press ▲ and ▼ to alter the charging current. Press and hold ENTER button for a second to start the charging process.

# QUICK START GUIDE

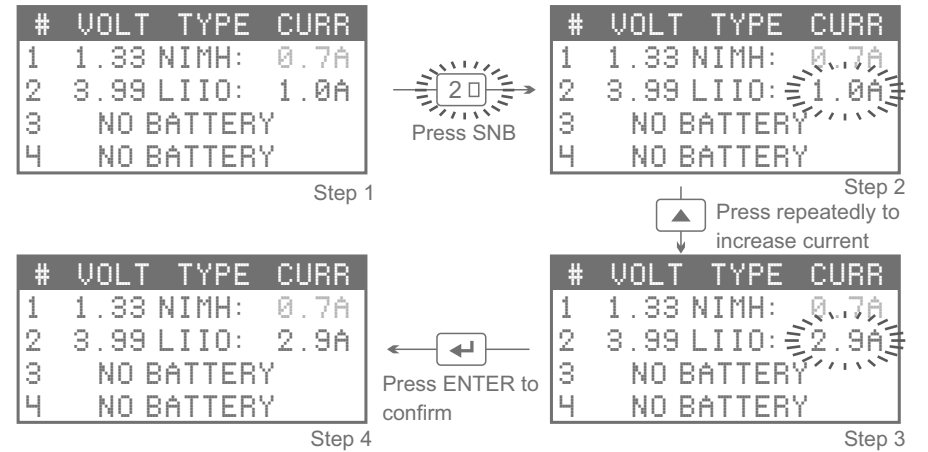

When battery is fully charged the LED of SNB will turn green and you will hear beep tone.

### Video Tutorials

Please scan and watch the tutorial video above how to operate the charger in dummy mode.



5. To change Dummy Mode to Simple or Advanced Mode click STOP to stop the operation of the charger first. Then press and hold the STOP button for one second to enter the SETUP menu.

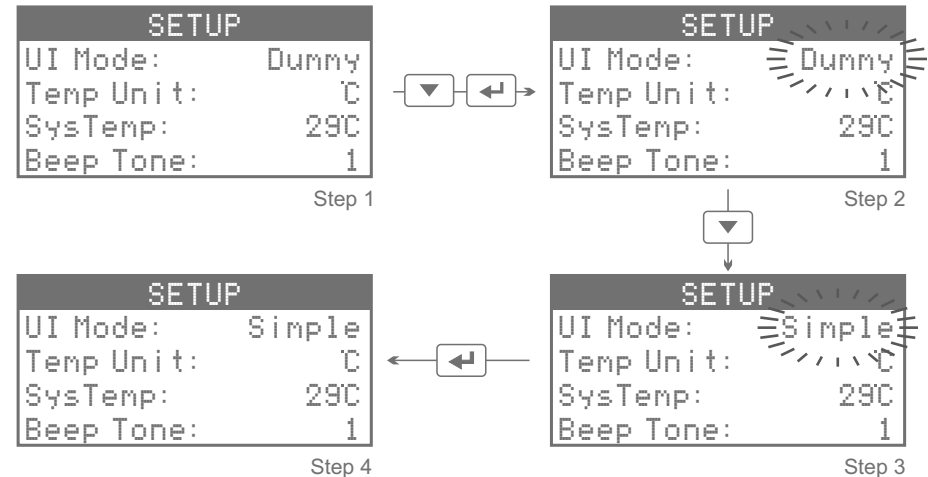

Press ▼ and ENTER, press ▼ again to select UI Mode. Press and hold ENTER to confirm selection. You will hear confirmation beep tone.



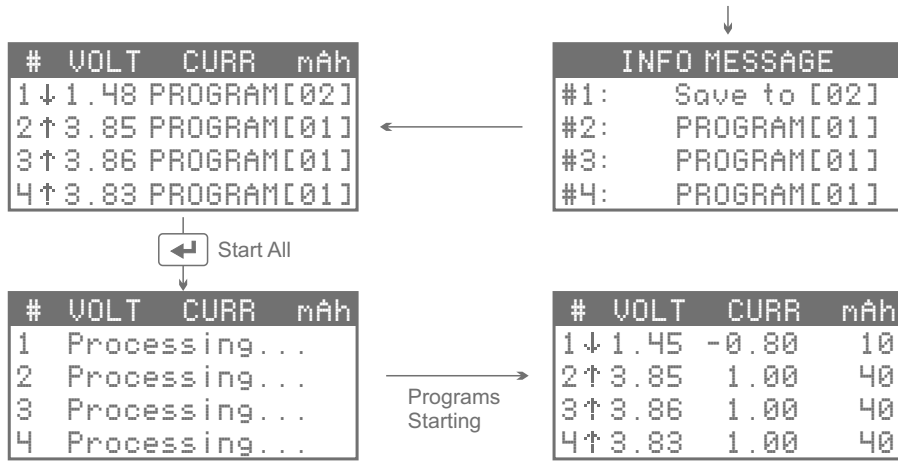

The parameters of other available program options can be changed in a similar manner. You must always assign safe correct programs to the battery. There are 30 programs which can be made for this charger.

**Video Tutorials**

Please scan and watch the tutorial video above how to make a program.



The following illustration shows how the five common views of the user interface are interconnected:

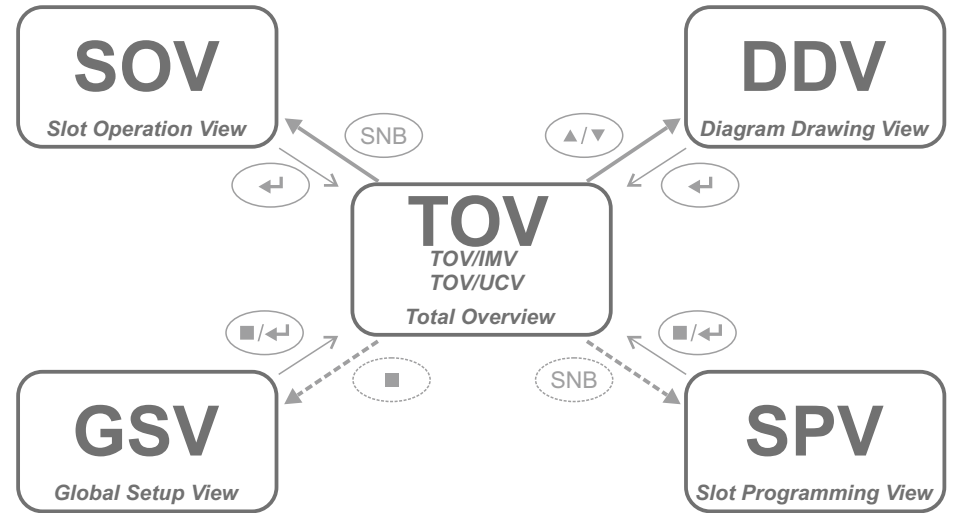

The following table gives you a rough idea of the controls in the user interface:

	Inactive Slot	Active Slot
SNB#1	click: go to SPV of #1 depress: START #1	click: go to SOV/DDV of #1 depress: STOP #1
SNB#2	click: go to SPV of #2 depress: START #2	click: go to SOV/DDV of #2 depress: STOP #2
SNB#3	click: go to SPV of #3 depress: START #3	click: go to SOV/DDV of #3 depress: STOP #3
SNB#4	click: go to SPV of #4 depress: START #4	click: go to SOV/DDV of #4 depress: STOP #4
STOP	press in SPV/GSV: CANCEL, QUIT depress in TOV: go to GSV	press in SOV/DDV: FINISH press in TOV: STOP ALL
UP	press: scroll up thru SPV/GSV	press: scroll up thru SOV/DDV
DOWN	press: scroll down thru SPV/GSV	press: scroll down thru SOV/DDV
ENTER	click in SPV/GSV: ENTER depress: SAVE & EXIT	press in SOV/DDV: RETURN to TOV press in TOV: START ALL



## What Does 0.5C, 1C, -C/4, Etc Mean?

It is a short way of specifying charge transfer rates as function of battery capacity. Substitute the nominal capacity for "C", divide by 1h, then multiply with the factor. For example, 0.3C for a 2100mAh battery equals a charge rate of 630mA or 0.63A (= 2100mAh/1h \* 0.3 ), -C/4 or -0.25C for a 3400mAh battery equals discharging it at 0.85A.

## Choosing The Right Discharging Rate

The battery industry defines the so-called "standard discharge" as a constant current -0.2C discharge at room temperature; per definition, discharging a fully charged new battery under these conditions will yield its nominal capacity. Furthermore, battery manufacturers often list minimum or rated capacities at higher, more typical discharge rates such as -0.5C or -1C in the specification sheets. Yet a more common practice for analyzing and comparing batteries from different sources is to always assume the same fixed discharge current, -0.5A or -1.0A, i.e. decoupled from the nominal capacity.

## Choosing The Right Charging Rate

Rechargeable Li-batteries. Battery manufacturers define the so-called "standard charge" most often as a 0.5C charge at room temperature. The user is advised to look up the confirmed details in the battery specification sheet.

Rechargeable Ni-batteries. Charging too fast may damage the battery and not charge as fully, whereas charging too slow requires longer time and may prevent the charger from terminating correctly. Hence charging at a rate below 0.3C or above 1.0C is not recommended unless otherwise indicated. In case of doubt, adhere to indications on the battery wrapper, look for the spec sheet, visit candlepowerforums, or call the battery manufacturer and ask for the optimal charging rate.

## Battery Matching

As a general rule, do not mix batteries of different types, different capacities, different voltages, or from different manufacturers in a multi-cell application. Use the Refresh mode to determine capacities of the same battery product, then group matching cells within ±5% of the measured capacity. Unmatched batteries in a multi-cell application can lead to reduced performance or runtime, or ultimately to battery damage, over discharge or reverse polarity.

## Battery Forming Charge

NiMH/NiCd batteries, new or stored for extended period, can become chemically deactivated. Battery forming charge is a charge-discharge-charge cycle which forces a full charge into the battery at a very slow rate. This process reactivates the battery. In certain cases, it needs to be repeated two or three times. Battery forming charge can be emulated by using the Break\_in mode with the C>D>C sequence. For very best health and condition though, cycling two or three times at standard charge/discharge rates may be more effective.

Battery manufacturers commonly specify recommended charge and discharge rates in datasheets dependent on minimum, rated, typical, or nominal battery capacity. In practice it is easier to compare the performance of different batteries by choosing a fixed pair of convenient rates, for example either 1.0A/-0.5A or 1.0A/-1.0A, and reusing it for all batteries of similar or not so similar size or capacity. In most cases it is not necessary to alter the default values. In fact, it is dangerous to increase the maximum charge voltage of Lithium-Ion batteries, and it is bad for battery health to discharge below the minimum discharge voltage.

	Lilon	Lilo4.35	LiFePO4	NiMH / Eneloop	NiCd	NiZn
Nominal voltage	3.6V 3.7V	3.8V	3.2V	1.2V	1.2V	1.65V
Charge voltage max. (range)	4.20V 4.00~4.25V	4.35V 4.10~4.40V	3.60V 3.40~3.65V	1.65V 1.47~1.80V	1.65V 1.47~1.80V	1.90V 1.80~1.95V
Restart voltage (range)	OFF 3.98~4.18V	OFF 4.08~4.33V	OFF 3.38~3.58V	OFF 1.30~1.45V	OFF 1.30~1.45V	OFF 1.78~1.88V
Storage voltage (range)	3.80V 3.65~4.00V	3.90V 3.75~4.10V	3.30V 3.15~3.40V	n/a n/a	n/a n/a	n/a n/a
Standard charge	0.5C	0.5C	1C	0.5C	0.1~0.5C	0.5C
Rapid charge	≤1C	≤1C	≤4C	≤1C	≤1C	≤1C
Standard  discharge	0.2C	0.2C	0.5C	0.2C	0.2C	0.2C
Typical  discharge	0.5~2C	0.5~2C	1~8C	0.2~2C / 0.5~3C	0.5~2C	1~10C
Disch voltage min. (default)	2.50V 3.00V	2.75V 3.30V	2.00V 2.40V	0.95V 1.00V	0.85V 0.90V	1.00V 1.30V
(range)	2.50~3.65V	2.65~3.75V	2.00~3.15V	0.50~1.10V	0.50~1.10V	0.50~1.50V

*How to get there* — Depending on the situation, depressing the STOP button or clicking it once, twice, or thrice will get you back to TOV.

*How to exit* — In TOV, remove all batteries and unplug the device from mains.

#	VOLT	CURR	mAh
1	NO BATTERY		
2	4.18	0.00	3467
3	4.20	2.99	1289
4	3.75	PROGRAM[05]	

The total overview (TOV) is the main view where other views automatically revert to after periods of user inactivity. In tabular format, it shows at a glance the most important bits of information about the operation of the slots. The top line marks the column headers for slot number (#), battery voltage (VOLT), current (CURR), and the transferred electric charge (mAh), often lackadaisically called capacity. The 2nd row starts with "1", for #1, and thus refers to the first slot, i.e. the slot with the number 1 on its slot number button (SNB#1); the next row starts with "2", etc. The symbol next to the slot number indicates the operation mode. Voltage is displayed in units of 1 Volt (1V) rounded to 2 decimals, current is displayed in units of 1 Ampere (1A) also rounded to 2 decimals. Tracking the full resolution of 3 decimals (+0.001V, +0.001A) is possible through the PC software interface only. Capacity is measured in units of 1 milliAmpere\*hour (1mAh).

When a battery is inserted – please mind correct polarity insertion – its voltage is displayed along with the specific program assigned to the slot and identifiable through its program number. Unless you are sure that this is indeed the program you intend to run on your battery, you must check or change the program number or the program settings.

TOV is also used for displaying message or quick info lines, for example at abnormal program termination. In case of an error, the SNB would be blinking red and it is then up to the user's discretion to find out how to quit the error message. When certain views such as SOV or SPV return to TOV, the rows display for the duration of an instant helpful or not so helpful info snippets regarding the respective program number.

**The controls in TOV are as follows:**

- When there are ready slots, pressing the ENTER button (=Start) will start them at once. This is useful if you do want to start all the ready slots together at the same time.
- If there are active slots, i.e. finished or busy, pressing the UP or DOWN button will get you to DDV; otherwise it has no effect.
- When there are active slots, pressing the STOP button (=Stop) will stop them simultaneously.
- If all slots are inactive, i.e. ready or empty, depressing the STOP button (=Setup) will get you to GSV.
- Clicking the SNB of an inactive slot will get you to its SPV.
- Clicking the SNB of an active slot will get you to its SOV, whereas depressing it will stop the slot. The latter is useful if you want to fully stop the operation of particular single slot and not just finish its program.
- Depressing the SNB of a ready slot will start the assigned program in the slot. This is useful if you want to start the ready slots individually.
- Depressing the SNB of an "empty" slot will try to release the tripped protection circuit of protected Li-Ion batteries. Repeat this procedure a few times until the seemingly empty slot has turned into a ready slot.

#	VOLT	CURR	mAh
1	1.26	-1.50	432
2	1.49	0.03	2378
3	3.07	0.00	3109
4	3.85	-0.04	654

By looking at the algebraic sign and the symbols or their inversions it becomes evident at which program stage the slots currently are. The symbols for the operation modes are as follows. The inverted version appears in TOV after program completion:

- Symbol for CHARGE operation mode: ↑
- Symbol for DISCHARGE operation mode: ↓
- Symbol for REFRESH operation mode: †
- Symbol for CYCLE operation mode: ∂
- Symbol for STORAGE operation mode: ∞
- Symbol for BREAK\_IN operation mode: ✨
- Symbol for TRICKLE charge: T
- Symbol for RESTING routine: +



*How to get there* — In TOV, if all slots are inactive, depressing the STOP button will transfer to GSV.

*How to exit* — In GSV, pressing the STOP button once or twice will cancel changes, quit the view and return to TOV.

```

SETUP
UI Mode:  Advanced
Temp Unit:  C
#1,#2:    29C,  28C
Beep Tone:  15
    
```

The MC3000 has numerous explicit options and their respective parameters which the user can check or control. The more general settings are accessible in the global setup view (GSV). They affect the operation of the entire device, not only of a single slot or program. Changes made to the options are not saved until the view is quitted by depressing the ENTER button (=Save).

The controls in GSV are as follows:

- Pressing the UP or DOWN button navigates through the items, or lets the user make a selection.
- Clicking the ENTER button (=Enter) enters an option, confirms a selection, or navigates through all items from top to bottom.
- Depressing the ENTER button (=Save) saves all changes and then transfers to TOV.
- Pressing the STOP button (=Cancel, Quit) cancels changes and ultimately may transfer to TOV, thereby restoring the original SETUP.
- In GSV, the SNB's are not responsive.

The items are in alphabetic order:

## Beep Tone

Lets the user turn off the annoying beep tone at system events, e.g. when clicking buttons. Or adjust its pitch for less irritation. Very useful.

## Calibration Reset

Lets the user perform a reset of the device calibration back to production conditions. Clears user-entered calibration data, typically 4 voltage measurements and 4 current measurements in total, and restores the original calibration which was delivered ex factory. All user-entered calibration data will be lost by overwriting. This reset is independent from the Factory Reset and affects calibration data only.

## Cooling Fan

Lets the user control the behaviour of the internal cooling fan. For example, "40°C" means that the fan will remain off under 40°C SysTemp, then turn on at full speed to help the cooling and eventually turn off at 35°C. "Auto" uses a super clever algorithm to calculate the optimal threshold temperature at your personal environmental setup. When temperature continues to increase from that start point on, rotational fan speed increases too.

## Display

Lets the user control the behaviour of the LCD background lighting. For example, "1min" means that the backlight will turn off after 1 minute of user inactivity, i.e. no pressing of buttons within that period of time.

## Factory Reset

Lets the user clear memory and perform a soft reset back to original settings of the present firmware version. In particular all changes made in programs and GSV will be lost. This reset is independent from Calibration Reset and does not affect calibration data. Once a firmware update is applied, the original ex-factory firmware version will be lost, so be prepared to adopt the newer firmware version for good.

## FW Version

Shows the firmware version. A factory reset may be required to finalize the firmware update procedure and show the updated firmware version.

## Hide NiCd / Hide NiZn / ...

Lets the user hide less common battery types as possible parameters for the BATT TYPE option in SPV. Hiding them allows for faster selection of the more common battery types Lilon and NiMH when programming slots.

## HW Version

Shows the hardware version.

## Info Message

```

INFO MESSAGE
#1:    PROGRAM[01]
#2:    Using [29]
#3:    Saved to [07]
#4:    Copy of [13]
    
```

Lets the user set the time period for displaying information snippets in the info message view (IMV). IMV contains differentiated information about the usage of program numbers in the four slots. TOV is preceded by a short display of IMV when, for example, SOV or SPV gets transferred back to TOV. Beginners may find it helpful to increase the time, the default is 2 seconds. Note that all interaction with the device is blocked during that time.

## SysTemp → #1,#2 → #3,#4 → ...

Shows the temperature as recorded by temperature sensors placed right at the internal aluminum cooler and as reported by the 4 sensors at the slots. Note that these are correct values at the sensors themselves and cannot be precisely the spatial temperature average of the targets of interest. Since it is practically impossible to isolate thermal paths in a compact 4-bay charger, heat may reach the different sensors from various directions and sources, hence actual battery temperature will be higher or lower than indicated, depending on the complex charging and the environmental situation.

## Temp Unit

Lets the user choose the preferred temperature unit to be displayed in GSV, SPV, SOV, and elsewhere.

## UI Mode

Lets the user switch between a shorter (default) or an extended programming menu in SPV. The Simple menu mode assumes reasonable fixed parameters for the options which are available in Advanced mode yet hidden in Simple mode; their preset values can be inspected from within the Advanced menu after a factory reset, for example identical 60min resting between charge and discharge routines.

Alternatively, a semi-automatic user interface can be activated which recognizes the given two battery chemistries automatically and does nothing but a full Charge. NiMH covers full charging of NiMH, NiCd and Eneloop; Lilon covers safe charging of Lilon and Lilo4.35. This UI mode may be convenient when the user just wants to recharge common batteries and not bother much about the technical details of the Charge operation mode. However, caution advised.

*How to get there* — In TOV, clicking the SNB of an inactive slot will transfer to SPV.

*How to exit* — Pressing the STOP button will eventually lead back to TOV without any changes saved.

```
#2    PROGRAM[05]
BATT TYPE:   LiIon
MODE:       † Charge
CAPACITY:   4200mAh
C.CURRENT:   3.00A
```

## Function

In slot programming view (SPV) the user can either change the program number to swiftly activate any other of the 30 global programs, or edit the detailed settings of the chosen program.

## Conception

After transferral from TOV first thing to be clear about is the program number in the slot, because at any point in time a concrete program number is assigned to each slot and the user should always be aware of which program, identifiable by its 2-digit number in square brackets, is set to run in the slot under consideration. As the underlying concept behind the entire user interface, there cannot be any slot with no program number assigned to it.

## Saving

How or when are programs saved? Changes of program numbers are saved in situ, unless cancelled by pressing the STOP button (=Quit). Changes of program settings are saved after depressing the ENTER button (=Save); the user is then transferred back to TOV. Clearly, changes in the program settings are lost if not reconfirmed by depressing the ENTER button!

## Similar programs

A program which is currently in operation by an active slot could still be edited and saved under the identical program number for modified operation in a different slot. This practice of template functionality is not recommended but may sometimes be useful for making changes to an existing program without assigning new program numbers to similar programs every time. Ongoing slot operation with the original program will not be affected by the modified program settings until it is fully stopped and then restarted with the same program number. In general, the recommended procedure for creating similar programs is to assign new program numbers to them with the Save To program option.

## *The controls in SPV are as follows:*

- Pressing the UP or DOWN button navigates through the items, or lets the user make a selection.
- Clicking the ENTER button (=Enter) enters an option, confirms a selection, or navigates through all items from top to bottom.
- Depressing the ENTER button (=Save) saves all changes and then transfers to TOV.
- Pressing the STOP button (=Cancel, Quit) cancels changes and ultimately may transfer to TOV, thereby restoring the original program settings or program number.
- Pressing the SNB of another inactive slot will keep the present program number saved to the slot but cancel all changes made in the program settings, before switching to the SPV of the new inactive slot.
- In SPV, the SNB's of active slots are not responsive.

The list of program options in SPV for all battery types combined is as follows:

## **BATT TYPE**

In the present firmware the following battery types are supported:

- **NiMH** - Nickel-Metal Hydride battery, 1.2V nominal voltage. The most common type of consumer class AA size rechargeable batteries for cameras, equipment, flashes, flashlights, tools, toys, bedroom, etc.
- **NiCd** - Nickel-Cadmium battery, 1.2V nominal voltage. Has still its uses in today's world of battery packs but single cells have become a rarity as they are being phased out due to their environmental toxicity. Stay away from children.
- **NiZn** - Nickel-Zinc battery, 1.65V nominal voltage. Charges to 1.9V, cannot take trickle charge, should not be discharged lower than 1.3V. Low cost, high output cell, suitable for fast charging, can be cycled 200–300 times. PowerGenix is a notable maker of NiZn batteries.
- **RAM** - Rechargeable Alkaline battery, 1.5V nominal voltage. This unpopular battery type was implemented in the firmware from the very beginning but is also permanently hidden in the menus. Menu item made accessible exclusively to verified recent buyers of RAM batteries; send in proof of purchase for more questions.
- **Eneloop** - Not really a battery type but a brand name. Market leading professional grade NiMH-based low self-discharge industrial standard superior battery product originally made in Japan by Sanyo or FDK, now by Panasonic and also in China. The charging algorithm is the same as for NiMH but some options in SPV have been adapted for more convenient presets. Can be cycled 1800-2100 times according to claims in ads.
- **Lilon** - standard Lithium-Ion battery, 3.6V 3.7V nominal voltage. Most common are Li-cobalt and Li-manganese based chemistries, both can be charged safely with this setting. Lilon charging uses the recommended CC-CV charging algorithm with user-definable termination current. Target voltage is 4.20V. Setting it higher is dangerous, and protected 18650's would not let the charger charge higher than that. Note that single non-cylindrical Li-Ion cells are omnipresent in smartphones and similar portable electronic devices, gadgets, digicams, grooming appliances, and in theory could be analyzed in the MC3000 too with the help of crocodile clip charging cables

or other aids, but for safety reasons the user is advised to resort to dedicated hobby chargers in such cases.

- **LiFe** - Lithium Iron Phosphate battery, LiFePO<sub>4</sub>, 3.2V nominal voltage. A safer Lilon chemistry, charges to 3.65V, must not be discharged lower than 2.0V. Not to be confused with Lithium Polymer battery, LiPo.
- **Lilo4.35** - Lithium-Ion battery, 3.8V nominal voltage. Very similar to standard Lithium-Ion but these cells can be charged safely up to 4.35V. Samsung is the only known high-quality manufacturer of such non-standard Li-Ion cells apart from LG. Since this menu item is potentially hazardous to ignoramus, it becomes hidden after a factory reset. To be clear, you must NOT use this battery type setting with standard Li-Ion batteries!

## **MODE**

There are up to 6 typical charging programs, or operation modes, to be found in hobby chargers and advanced battery chargers. MC3000 has them all, and additional ones could be provided in future firmware upgrades.

- **Charge** - Charges your battery. Uses the proper algorithm for the chosen battery type, constant current (CC) for NiMH, CC for Eneloop, CC-CV for NiZn, CC-CV for Lilon, etc. Charging terminates when the battery is full or some other termination criteria have been met. Useful when battery needs to be recharged without determining the capacity of the battery. Should be used on batteries known to be in good condition and which have been in continuous use. Requires the least amount of time.
- **Refresh** - Practically the same as Cycle operation mode with setting C>D>C and N=1, first charges, then fully discharges, followed by a full recharge, with rests in between. Reports discharge and charge capacities after the end of the cycle. Useful for automatically analyzing battery capacity while ending up with fully charged batteries. Also useful for rechargeable Ni-batteries with degraded performance, recommended once every ten cycles for NiMH batteries. Note that this or similar operation mode has confusing names in other battery chargers, Refresh&Analyze Mode, Test Mode, Nor Test Mode, Check Mode, Cycle Mode, Alive Mode, etc. MC3000 doesn't call it names, just look at its fixed program definition in SPV.
- **Break\_in** - Based on norm §7 of IEC 61951-1 Ed. 3.0 2013-10 and IEC 61951-2 Ed. 3.0 2011-05, this mode enables the user to perform the industrial standard procedure to verify the declared rated capacity of single NiCd or NiMH cells. The norm specifies that first the battery shall be discharged at -0.2C constant current down to 1.0V cut-off, then charged at 0.1C CC for exactly 16h including a 6h overcharge, afterwards stored for 1-4h, and finally discharged for at least 5h at -0.2C CC down to 1.0V cut-off again. This 28h+ long D>C>D procedure shall be repeated up to 5 times until the rated capacity has been met, otherwise the battery rating is no good. Similarly, the 39h+ long C>D>C procedure can serve as battery forming charge, once every 30 cycles for NiMH batteries or every half year, recommended both for brand-new batteries and for batteries that cannot be rescued by the Refresh mode. Because of the timer based charge termination Break\_in cannot be simulated by the Cycle operation mode. Not available for NiZn nor for rechargeable Li-batteries.
- **Discharge** - Primitive operation mode which does nothing but 1 discharge routine, D, eventually followed by a rest phase, i.e. D>. Maximum discharge current is -2.00A for all battery types, restrictions apply. Useful for analyzing the remaining amount of electric charge stored in the battery.

- **Cycle** - Automatically repeats the three distinct routines after the specified pattern. Useful for unattended operation over an extended period of time or testing the degradation of China made Eneloop after 100 cycles. Cycling a few times at high rates may help to condition new NiMH cells or awake old batteries from slumber; interrupt the cycling when the discharge capacity has seemingly reached a plateau. Note that a battery can be re-cycled only so many times before its end-of-life.

- **Storage** - Available for rechargeable Li-batteries, generates recommended stable voltage levels in preparation for long-term storage. Uses the technique of reduced charging (CV-phase) and reduced discharging (inverse CV-phase) to approach the target voltage. For storing rechargeable Ni-batteries, no such preparation is needed, see BU-702.

## **CAPACITY (or NOMINAL)**

Primarily meant as safety option, lets the user set a reasonable upper limit for the transfer of electric charge per discharge or charge routine of a program. Enter, for example, 4200mAh for a 20% buffer on a 3500mAh rated battery. The capacity cut-off is to prevent overcharging or overdischarging, especially of batteries with unknown performance or capacity. Or, may be set to stop the slot prematurely on purpose after the transfer of a well-defined amount of electric charge. In some situations it may be convenient to just set it to OFF. In Break\_in mode, this option is labeled NOMINAL and the user is required to enter a value as exactly as possible, the nominal capacity of the battery.

## **C.CURRENT**

The nominal charge current. Must be set for operation modes which include at least 1 charging routine. In Simple menu mode the charge current is set in +0.1A steps from 0.1A to 3.0A; in Advanced menu mode it is set in +0.01A increments from 0.05A to 3.00A. It is OFF for Discharge, and preset for Break\_in operation modes. MC3000 uses constant current for charging, not pulsed charging. Note that the initial charging current automatically decreases during the CV-phase of Lilon charging or storage mode. For programs with even lower CC charging currents than 0.05A, you could try to be clever with the TRICKLE C. option.

## **D.CURRENT**

The nominal discharge current. Must be set for operation modes which include at least 1 discharging routine. In Simple menu mode the discharge current is set in +0.1A steps from -0.1A to -2.0A; in Advanced menu mode it is set in +0.01A increments from -0.05A to -2.00A. The device can discharge 4× Ni-based batteries at -2A/slot or 4× Li-based batteries at -1A/slot at a time. However, the device can discharge only 1× Li-based battery at -1.01...-2.00A at a time; when another slot is started, all busy slots would be cut in their discharge power in parallel. So in order to guarantee 1× Lilon battery at -1.01...-2.00A undiminished discharging current, no other slot can be busy. MC3000 uses constant current for discharging, not pulsed discharging. Note that the initial discharging current automatically decreases when the D.REDUCE option becomes active. For programs with even lower discharging currents than -0.05A, you could help yourself and play with the D.REDUCE option.

## **C.RESTING**

Defines the duration of the resting phase subsequent to the charging routine. Can be set to anything between 0 and 240 minutes for operation modes which include at least 1 charging routine. During this period the current is 0.00A, or trickling if TRICKLE C. was set, and the battery can cool down and rest. It is OFF for Discharge operation mode, and there is no resting phase after a cycling operation mode has finished.

## **D.RESTING**

Defines the duration of the resting phase subsequent to the discharging routine. Can be set to anything between 0 and 240 minutes for operation modes which include at least 1 discharging routine. During this period the current is 0.00A, and the battery can cool down and rest. It is OFF for Charge operation mode, and there is no resting phase after a cycling operation mode has finished.

## **CYCLE COUNT**

Number of cycles. Option relevant only to cycling operation modes such as Cycle (N=1...99) or Refresh (N=1). It is OFF for all other operation modes including Break\_in. As in sports a trade-off, cycling repeatedly is good for present health, condition and performance on the one hand, on the other hand it ages substance faster and shortens lifespan. Ambitious battery testers can learn about the decline of capacity after numerous cycles.

## **CYCLE MODE**

For our purpose, a so-called cycle be defined as sequence of at least 1 charging and 1 discharging routine, or vice versa. "D>C>D", for example, will start with an initial discharge before performing a complete charge followed by a complete discharge. For N>1 the program repeats the pattern such that a complete charging routine always alternates with a complete discharging routine, or vice versa. "C>D>C, N=2" would result in (C)>D>C>D>C, "C>D, N=2" in (C)>D>C>D. While the user can specify C.RESTING and D.RESTING to be applied between the charge transfer routines, the program finishes directly after the final charge transfer routine with no further rest phase applied.

## **TARGET VOLT**

Similar to CUT VOLT, it states the direction and target, i.e. the voltage where the charging routine is heading towards to terminate the routine. Often termed 'end voltage', the exact technical meaning of this value differs slightly depending on battery chemistry or operation mode: the charging of a NiMH/NiCd battery ends as soon as the off-load voltage has reached this point, or it is the on-load constant voltage during the CV-phase of rechargeable Li- or NiZn-battery charging, or it is the storage voltage in the Storage mode of rechargeable Li-batteries. Unless you're sure why you're doing what, better stay on the safe side and do not deviate from the default values.

## **CUT VOLT**

The discharge cut-off voltage. Applies to discharging routines of operation modes other than Storage. It is the voltage, measured under load, at which the routine will terminate the discharging; or, when D.REDUCE is active, it is the constant voltage during the inverse CV-phase until the routine terminates the discharging. Before the start of the discharge, this value should be lower than the battery voltage to make any sense. If set too low, the overdischarging will damage the battery.

## **CUT TEMP**

The temperature cut-off. It is the temperature of the battery, or more precisely the temperature at the slot sensor, at which the program will stop with an abnormal program termination message. A safety option, it can protect batteries against unexpected overheating. While recommended for better air circulation around the round battery, measurement of battery temperature will be particularly off when the battery is left hanging suspended between the contacts.

## **CUT TIME**

The timer cut-off. Stops the program with an abnormal program termination message when the total time has reached this value. Primarily devised as safety option, it could also be used for intentional program stops after a given time of operation, for example in conjunction with the Zero or -Zero parameters of the Storage operation mode.

## **TERMINATION**

The termination current of the CV-phase of Li-Ion battery charging algorithm, also of NiZn. When reaching TARGET VOLT, e.g. 4.20V, this option will hold the voltage constant while automatically reducing the current down to the specified value before it terminates the charging routine. A high termination current serves battery health but will not charge the full battery capacity. The parameter defaults to 10% of C.CURRENT, an industrial standard. "Zero" means an ever decreasing charging current: not good for your patience or battery but allows to produce quasi-constant 4.200V battery voltage if that's what you're after. OFF means no CV-phase once the target voltage has been reached.

## **D.REDUCE**

Discharge Reduce. Applies to the discharge routine of a program. Inversely similar to the CV-phase of Li-Ion battery charging algorithm, when reaching CUT VOLT, this option will hold that voltage constant while automatically reducing the current down to the specified value before it terminates the discharging routine. Setting this option will extend the discharging period beyond the time for normal discharge cut-off, discharge even more electric charge, but never let the battery fall below the cut-off voltage. Since battery offline voltage tends to recover after a discharge process, reducing the discharge current helps to reduce the extent of recovery. "-Zero" means that the discharge current will continue to decrease, approaching 0A infinitesimally; beware, this could take forever and may also not serve battery health. Not terribly useful in most cases, the Storage operation mode does profit from this option though. If you are confused, just turn it OFF.

## **RESTART VOLT**

The restart voltage. Applies to programs which end with a charging routine. When such a program has finished, the voltage of bad-health batteries is prone to decline rather fast due to self-discharging phenomena. Setting this value for example 0.05V lower than TARGET VOLT will guarantee a minimum battery voltage when removing the battery. Naturally, one cannot set it higher than the TARGET VOLT parameter. What exactly will happen when the voltage has dropped by the 0.05V? That depends on the firmware version. Generally speaking, the slot restarts some charging. For all operation modes the factory default is OFF.

## **DELTA PEAK**

Delta-peak sensibility. A technical parameter to control charge termination of NiMH/NiCd batteries through the commonly recommended negative delta voltage -dV or -dV/dt method, or through the zero delta voltage method, 0dV or 0dV/dt. When charging a healthy specimen at constant current the voltage graph normally peaks around full charge completion. A higher setting will ensure that this peak has been passed with certainty but will also charge longer than necessary. "0dV" will terminate the charging when the peak extends to a voltage plateau, i.e. does not show a well defined voltage drop. The latter may happen with old batteries or at very low charge rates or both. As a rule of thumb, use -dV for topped off charging and 0dV as no-brainer in all other cases.

## **TRICKLE C.**

Trickle charge. A small constant current applied after the charging routine, available for NiMH/NiCd batteries only. Once set, it applies to all rest phases after charging routines, in particular to finished slots which ended with a charging routine. Trickle charge helps to keep the batteries topped off, i.e. fully charged. A too high value may overcharge and keep the battery heated, which would not serve battery health. The factory default is OFF.

## **Save To**

Always defaults to the present program number in the slot under consideration. Allows the user to save the entire modified set of program settings under a different program number, leaving the original set of program settings intact. The parameter "Slots" facilitates setting up slots with identical programs. It allows the user to save the changes to the present program number but also copy the entire program including its program number over to all other three slots by overwriting their currently assigned programs; in currently active slots, the new program will not become active until the ongoing program has finished.

Example: You're editing PROGRAM[03] in slot#1, generating a "[03\*]" in #1 so to speak. The last row in SPV defaults to Save To [03]; depressing the ENTER button would just save [03\*] to [03] and make it the active program in #1. Depressing the ENTER button on Save To [05] would save [03\*] as program[05], overwriting whatever PROGRAM[05] has been before, and return to TOV; the original [03] stays intact in #1, untouched. If slot#2 was assigned with [05] before, then #2 would be now ready to run "[03\*]" so to speak. Depressing the ENTER button on Save To Slots would first save [03\*] to [03] and then make it the new program in all slots.



*How to get there* — In TOV, when there is at least one active slot, clicking its SNB will transfer to SOV.

*How to exit* — In SOV, pressing the ENTER button will return back to TOV. Or, after some period of user inactivity, returns to TOV automatically.

```
#2      LiIon
Mode:   ↑ Charge
Capacity: 9mAh
Volt:   3.97/4.20V
C.Current: 2.99A
```

Naturally the slot operation view (SOV) is available for active slots only, i.e. slots with an ongoing program (SNB: solid red) or slots with a finished program (SNB: solid green). For such slots, SOV can be accessed through TOV. Apart from the most basic info already given in TOV, it also shows quantities such as power, energy, time, temperature, internal resistance, and target voltage. Whenever SOV is transferred back to TOV, the program numbers of the slots are being displayed for a short period in the info message view (IMV).

### The controls in SOV are as follows:

- Pressing the UP or DOWN buttons will scroll through the info lines.
- In SOV, SNB's of inactive slots are not responsive.
- For active slots, clicking the SNB will switch to its SOV, whereas depressing the SNB will fully stop the slot. The latter will make the SNB turn from solid red or solid green to blinking red-green.
- Similarly to DDV, for busy slots, pressing the STOP button (=Finish) will stop the ongoing routine and finish the entire program at this point, prematurely. The SNB turns from solid red to solid green. This function provides some manual interactivity and control, if ever needed.
- Pressing the ENTER button (=Return) will return back to TOV.

The top line shows the slot number to the left and the battery type to the right. The items are in order:

### Mode

Shows which kind of operation mode is running, or has finished, in the slot. For example, the NiMH battery type has 5 possible operation modes: Charge, Refresh, Cycle, Break\_in, Discharge. For fast identification each operation mode is accompanied by a corresponding symbol.

### Capacity

Shows the absolute value of the accumulated electric charge as it is being transferred between device and battery: discharging capacity during discharge routines, charging capacity during charge routines. At the end of cycling programs such as Break\_in, Refresh, or Cycle, the results of their discharging routines are shown too. The original physical unit is Coulomb, or more typically, milliAmpere\*hour (1mAh).

### Volt

Shows both the actual battery voltage and the end voltage, i.e. the voltage where the charging or discharging routine is heading towards to terminate the routine. In SPV, for discharging routines the end voltage is called the cut-off voltage (CUT VOLT), for charging routines it is called the target voltage (TARGET VOLT), and for the storage operation mode it is called the storage voltage (TARGET VOLT, too). The physical unit is Volt (1V). While both values are displayed with 2 decimals, internally the device measures with +1mV resolution and accuracy.

### D.Current (or C.Current)

Shows the actual current flowing through the battery as it is being measured by a precision sub-Ohm current sense shunt in real time. Negative values represent discharge currents, positive values charge currents, according to EE101. The physical unit is Ampere (1A). While the value is displayed with 2 decimals, internally the device measures with +1mA resolution and accuracy.

### Power

Shows the momentary time rate at which electric energy is being transferred between device and battery. Mathematically, electric power of the battery is simply the product of momentary battery voltage under load and momentary battery current. Following the passive sign convention, negative values represent a battery being discharged, positive values a battery being charged. The physical unit is Watt (1W). Roughly speaking, the max charge power is about 13W/slot, the max sustainable continuous discharge power is about -13W/device.

### Energy

Shows the amount of electric energy which has been transferred between device and battery since the start of the ongoing charging or discharging routine. A positive value means energy transfer from device to battery (charging), a negative value means energy transfer from battery to device (discharging). Not all energy transferred from device to battery is stored in the battery; some part of it gets lost in the immediate environment in form of dissipated heat, mostly due to the internal resistance of the battery. The physical unit is Joule, or more typically, Watt\*hour (1Wh).

### Time

Routine time. Shows the elapsed time since the start of the present routine. A program can consist of several routines. When a new routine within a program starts, this timer is reset to zero.

### Total

Total time. Shows the elapsed time since the start of the program. In SPV, for long-term cycling make sure to set the parameter of the CUT TIME program option to OFF because CUT TIME is limited to 1 day, whereas the timer of Total can count up to days and days.

### BattTemp

Shows the battery temperature, or to be more precise, the slot temperature. Same value as seen in GSV, it mostly serves as safety feature for battery overheat protection. To change the temperature unit, go to GSV and change Temp Unit. Note that physically, temperature is a scalar field quantity, i.e. any point on the battery surface will have a different temperature and depending on the charging situation and your environment, the extreme temperature points on your battery may be notably cooler or warmer than the single value given here.

## **SysTemp**

Shows the internal system temperature. Same value as seen in GSV, it serves as safety feature for device overheat protection. At full load it can go as high as 80°C or higher and will shut down operation thereabout. The cooling fan is controlled by this value.

## **Batt IR**

Shows the internal battery resistance in milliOhm (1mΩ). At the start of a program, the device always performs a quick standard test first in order to determine the internal battery resistance. Aged or poor condition batteries have a higher IR and therefore heat up more during charge or discharge. This measurement is fairly accurate and reproducible, yet battery contacting pressure and battery temperature may affect it.

*How to get there* — In TOV, if there is at least one active slot, clicking the UP or DOWN button will transfer to DDV.

*How to exit* — In DDV, pressing the ENTER button will return back to TOV. Or, after some period of user inactivity, returns to TOV automatically.

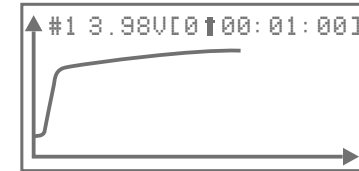

The diagram drawing view (DDV) is a convenient way to get a quick overview of the voltage graphs, or other graphs of relevant system quantities, over time. The scaling of both axes is changed dynamically in order to present the data in a meaningful way. Since the horizontal axis represents the total time, very long program durations, for example a CYCLE program with tens of cycles, will make the diagram look funny, so for higher resolution of data and graphs the user is advised to do some PC time with the PC Link software. During the operation of a program (SNB: solid red) and after finishing the program normally (SNB: solid green), the displayed voltage is live and in real time. DDV can be accessed from TOV only and there should be at least one busy or finished slot.

## **The controls in DDV are as follows:**

- Pressing the UP or DOWN buttons will cycle through the graphs of active slots.
- In DDV, SNB's of inactive slots are not responsive.
- For active slots, clicking the SNB will directly switch to its graph, whereas depressing the SNB will fully stop the slot. The latter will make the SNB turn from solid red or solid green to blinking red-green.
- Similarly to SOV, for busy slots, pressing the STOP button (=Finish) will stop the ongoing routine and finish the entire program at this point, prematurely. The SNB turns from solid red to solid green. This function provides some manual interactivity and control, if ever needed.
- Pressing the ENTER button (=Return) will return back to TOV.



Very similar to the technology of a modern digital multimeter, the microprocessor of MC3000 measures the actual battery current (in series) and the actual battery voltage (in parallel) directly at the battery in order to control and regulate the discharge or charge process. During the manufacturing process every MC3000 production unit gets tested and calibrated after highest factory standards. Ambitious users who trust their own expensive equipment more or who prefer their personal fluke to serve as reference have the possibility to adjust the MC3000 factory calibration by a few counts. Note that production calibration procedure, undocumented in this user manual, differs from the following documented calibration procedure in user calibration view (UCV).

### Steps for user calibration (Voltage):

#	VOLT	CURR	mAh
1	Calib.V:	4.103V	
	3.98		
	4.15		
	4.08		

1. Have a set of 4 batteries with stable offline voltage, preferably all over 4.0V, at hand. With your digital multimeter, measure their voltages accurately with a resolution of 3+ decimals in the "1V"-range setting, e.g. "4.10285V, 3.97013V, etc".
2. Have the MC3000 connected to power and display TOV. Insert all 4 batteries. Depress SNB#1 and the STOP button simultaneously until the battery voltage in slot#1 is being displayed with 3 decimals, e.g. "4.098V", and release the 2 buttons in time. You are now in voltage calibration mode for slot#1.
3. Enter your own measurement, in this example 5 counts up to "4.103V", with the help of the UP or DOWN button and save by depressing the ENTER button. Saving takes a few seconds.
4. Repeat the procedure similarly for the remaining 3 slots: depress SNB#2 and STOP simultaneously until the battery voltage in slot#2 is being displayed with 3 decimals and release, etc.
5. Recheck if the voltage readings of MC3000 and offline with your personal fluke do coincide for other batteries with stable voltages.

Note: One does not need 4 different batteries for voltage calibration. As long as the battery has stable voltage, the same battery can be reused in all 4 slots. Similarly, one does not need 4 different batteries for current calibration. As long as the battery is able to supply high constant current over the duration of the calibration process, the same battery could be reused in all 4 slots.

### Steps for user calibration (Current):

#	VOLT	CURR	mAh
1	Calib.C:	-1.006A	
2	3.90	-1.00	27
3	4.11	-1.00	16
4	4.06	-1.00	9

1. Have a set of 4 fully charged high performance batteries at hand. With your digital multimeter, get prepared to measure the battery current online in series accurately with a resolution of 3+ decimals in the "1A"-range setting.
2. Have the MC3000 connected to power and display TOV. Insert all 4 batteries. Run a constant current discharge program at -1.00A in slot#1. Wait until the multimeter shows a stable reading, e.g. "-1.00639A", then depress SNB#1 and the STOP button simultaneously until the battery current in slot#1 is being displayed with 3 decimals, e.g. "-1.000A", and release the 2 buttons in time. You are now in current calibration mode for slot#1.
3. Enter your own measurement, in this example 6 counts up to "-1.006A", with the help of the UP or DOWN button and save by depressing the ENTER button. Saving takes a few seconds. Observe how the multimeter reading automatically begins to drift from "-1.00639A" to a perfect "-1.000..A" booyah.
4. Repeat the procedure similarly for the remaining 3 slots: run the same -1.00A discharge program in slot#2, wait until the multimeter shows a stable reading, then depress SNB#2 and STOP simultaneously until the battery current in slot#2 is being displayed with 3 decimals and release etc.
5. Recheck if the current readings of MC3000 and online with your personal fluke do coincide for other programmed discharge rates, e.g. -0.05A, -0.10A, -0.50A, -1.50A, -2.00A.

In theory you could also use a lower voltage battery for voltage calibration or a lower discharge current for current calibration, however for guaranteed consistency across the 4 slots and the entire voltage and current ranges we do not recommend lower values than the above suggested ones. Since temperature of components and environment alters measurements by precision electronics, please make sure that user calibration is done under isothermal conditions to make any sense. In case of error or mistake, you can reset the calibration to ex factory conditions with the Calibration Reset menu item in GSV. Good luck.

The visualization of data helps with the understanding of battery performance or the details of charging algorithms. The free PC Link software offers convenient operation and overview of the charger from a Windows computer; it is also needed for downloading and installing the latest firmware updates. The software automatically retrieves the program settings of each slot, and with the click of a mouse the user can simultaneously monitor the most important quantities of the four slots through real-time graphs and, for example, track all charge and discharge capacities of an extensive cycle program. For more detailed analysis or post-processing the user could export the data to \*.CSV-spreadsheet format and import the file to MS Excel or other third-party software applications.

In order to connect the charger to the computer and use the PC Link software, the user is required to use a USB cable which is not included in this package. The cable must be terminated on one end with A plug and the opposite end is terminated with micro-B plug which can connect to charger directly.

As with any other smart piece of software, handling the program itself is intuitive and self-explanatory. For information on technical options and parameters, please refer to the corresponding sections in this manual.

In the present PC software version it is not possible to combine several programs, e.g. -2A discharge to 3.6V followed by -1A discharge to 2.8V, to a single composite program. In the meantime the user could program different charge steps in separate program numbers and carry out the combination of steps manually.

The latest version of the PC Link software for Windows PC can be downloaded from [www.skyrc.com](http://www.skyrc.com).

It is not necessary to update the firmware of a device because in most cases the user is good to go with the firmware version delivered ex factory. However firmware updates are an opportunity for the company to make small changes, expand the code and let the user profit from continued development without extra cost. User submitted suggestions for incremental changes in the firmware will be gathered, evaluated and decided upon on a regular basis. The updating procedure is as follows:

1. Remove all batteries. Connect the device to its power supply.
2. Use the PC Link USB cable to connect the device to your Windows PC, launch the PC Link software.
3. In the PC Link software click on Firmware Update and wait until the automatic download+updating has finished. WARNING: Do NOT interrupt the data transfer or power supply at any moment during the updating procedure because this may lead to permanent damage of the device!
4. Depending on the firmware version the updating process may conclude with an automatic soft reset, or not. The user is at liberty to check the update success and, if needed, perform a manual Factory Reset on top, see GSV.
5. No need to power off or reboot the device, your updated MC3000 is yet ready for operation. Go ahead and enjoy the updated code.

**Attention:** Note that in general a firmware update or factory reset inflicts loss of all user-saved settings in SPV and GSV, other than user calibration data. On the one hand the updating procedure tries to keep the user-entered settings intact whenever possible, on the other hand major changes in the code entail a soft reset performe. Hence before performing a firmware update, be prepared to bye-bye.

The Bluetooth 4.0 connectivity allows the user to remote control and monitor the MC3000 comfortably through an app on a portable device such as smartphone, iPad, or iPhone. The iOS app can be downloaded from iTunes Store, the Android app from Google Play Store. Operation of the app is self-explanatory and the same on iOS and on Android. Explicit pairing is not required; after download and installation just activate Bluetooth on your mobile device and launch the app. MC3000 and your device will establish Bluetooth connection automatically. The blue LED, located on the right side of the charger, indicates when there is Bluetooth activity going on.

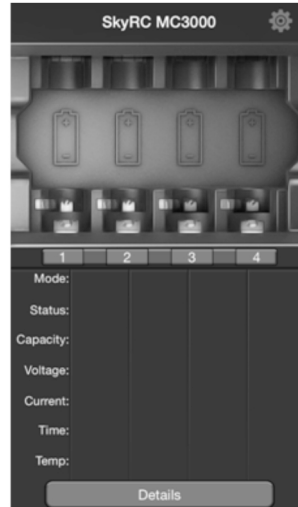

Scan with your iPhone to download.



Scan with your Android to download.

## Operation

1. Connect the power adapter to MC3000, then plug the power adapter into outlet (100~240V AC, 50/60Hz).

2. Insert battery, the corresponding slot will light up, the charger is on standby. Meanwhile basic information on battery and operation mode is displayed on the screen.

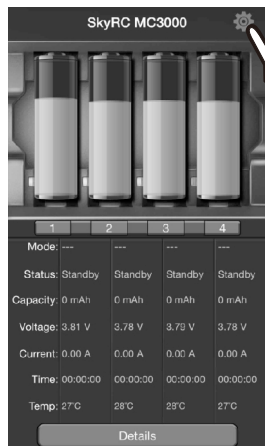

Enter Program Setting

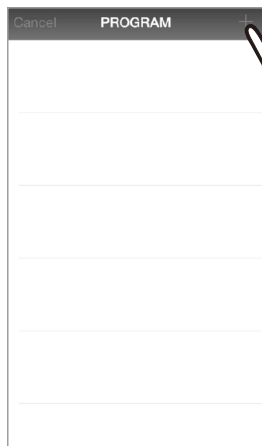

Add Program

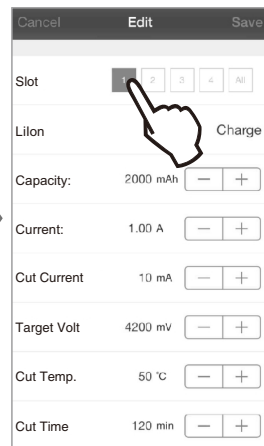

Select Slot

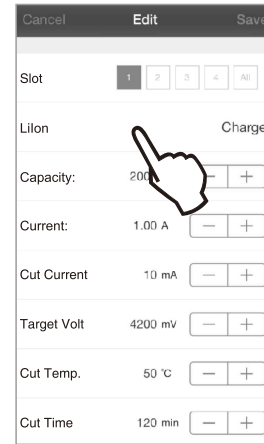

Select Battery Type and Operation Mode

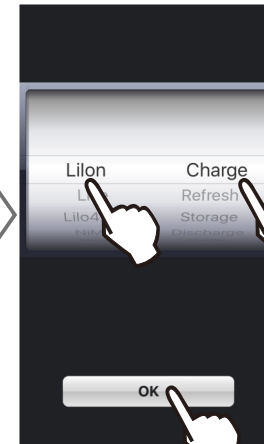

Press OK to Confirm

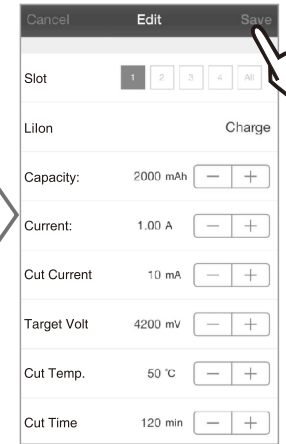

Press SAVE to Confirm

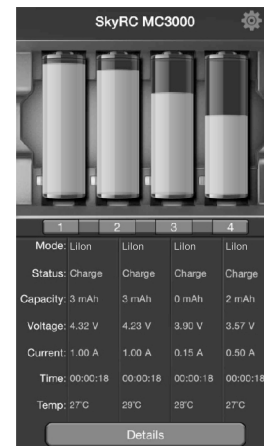

Start the Program

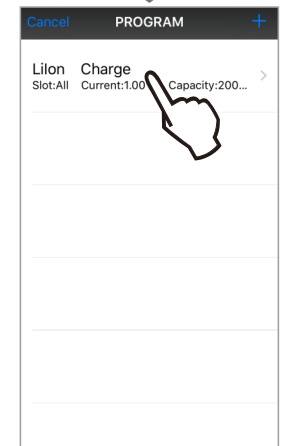
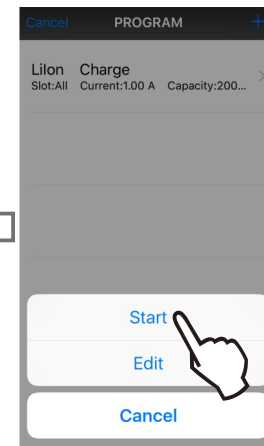

Enter the Program

## Video Tutorials

Please scan and watch the tutorial video above how to using apps to operate the charger.



3. Press 'Details' on the screen to view graphs and slot operation details, such as Battery Voltage, Current, Temperature, Resistance etc., in a single overview. The battery icon is for switching the view between slots.

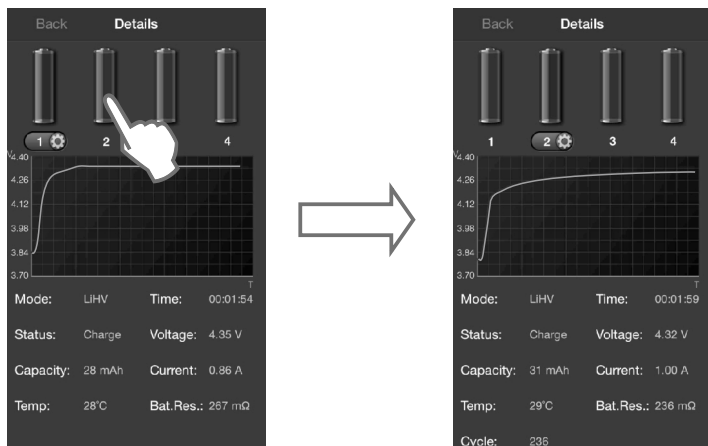

4. Pressing the slot number button will stop the operation of the program in that slot.



In case of abnormal program termination or other ordinary error the screen will display the cause of error and emit an audible sound.

<b>Capacity Cut</b>	User-set capacity cut-off value has been reached. Set it higher or OFF.
<b>Timer Cut</b>	User-set total time limit has been reached. Set it higher (<24h) or OFF.
<b>BattTemp Cut</b>	User-set battery temperature has been reached. Set it higher or OFF.
<b>SysTemp Too Hot</b>	Internal temperature alarm has been triggered. Stop all and cool off.
<b>Connection Break</b>	The battery connection of a busy slot got interrupted. Check the connections.
<b>Input Volt Too Low</b>	The input voltage is below 11V. Connect proper power supply.
<b>Input Volt Too Hi</b>	The input voltage is above 18V. Disconnect power and connect proper power supply.
<b>Reverse Polarity</b>	No such warning when a battery is connected incorrectly. Don't fool around.
<b>Short Circuit!</b>	No such warning when a slot is short-circuited. Don't mess around.
<b>Check Voltage</b>	Voltage of inserted battery seems off, mismatches the program for the slot. Check BATT TYPE in your program settings. Note that the minimum accepted voltage is 0.2V and the maximum voltage per slot must not exceed 5.0V.
<b>Calibration Err</b>	User calibration of the slot seems totally off. Perform Calibration Reset in GSV to prevent potential damage.
<b>Fan Disconnect Err</b>	The ventilation fan was supposed to start but there is no current flow. Check connection to PCB, check fan.
<b>Battery So Poor</b>	Bad condition cells or batteries with high internal resistance may be rejected.
<b>unknown err thx</b>	Spontaneous extraordinary internal error of unknown origin and magnitude, sneaky bug, thanks for your comprehension. Ignore or unplug from mains.
<b>UnhandledException</b>	\$\$\$%&B"#wth!

1) ***When I discharge 4 fully charged 18650 Li-Ion batteries at 1A/slot together at the same time, the plastic radiator grille gets hot, the metal (+) contacts too, but less so when I discharge a single Li-Ion battery at 2A. What's wrong with me?***

- Nothing. All is good. But if you don't feel comfortable with the high temperatures at full load, how about discharging two batteries instead? You will be surprised how not hot the externals get at reduced loads. In any case, no need to worry, the dissipated heat will not damage the charger or your batteries.

2) ***The fan is noisy. What are my options?***

- No, the fan is not noisy. The charger comes with a low-noise high-speed 30×30×7mm mini ventilation fan, firmly clipped to the inside of the bottom. You can check.

3) ***I am trying to discharge a Lilon with 1.5 amps plus a NiMH with 2 amps but the charger refuses to go higher than 1 amp for both. Why?***

- Because of the higher nominal voltage of rechargeable Li-batteries MC3000 allows only one busy slot to discharge such a battery at a rate higher than 1 amp; the presence of any second busy slot will instantaneously limit all four active or inactive slots in their respective maximum discharge power. This must have been explained before in the manual.

4) ***I've placed a flat top protected 18650 battery in the bay yet the slot info is still displaying NO BATTERY. How to proceed?***

- Check if the battery is inserted with correct polarity. Check if the battery terminals do make proper connection with the slot metal contacts; shift, suspend, or tilt the battery, if needed for securing the connection. 0V-batteries are displayed as NO BATTERY, so check if the battery protection is tripped; click the slot number button to release the protection.

5) ***Can I discharge non-rechargeables such as Alkaline or Lithium primaries? I would like to verify their rated capacities.***

- Primary batteries don't often come with a capacity rating but yes you could compare discharge capacities of primaries of different makes. Use BATT TYPE NiMH with D.REDUCE option for discharging Alkalines, use BATT TYPE LiFe for discharging Lithium primaries.

6) ***Keeps me wondering, what does the term 'nominal' or 'nominal capacity, nominal voltage, nominal charge rate, etc' actually mean? I read it so often here and there but never cared to read up on it.***

- Nominal is a word derived from Latin. The Latin word 'nomen' means name. Aha.

7) ***Does the charger have built-in protection against reverse polarity, short circuitry, overheat, overvoltage, overload, stupidity, ignorance, explorativity?***

- Do not misuse, abuse, or mess around. The device was built for proper responsible usage.

Understanding how to operate the device through its user-friendly interface is easy. For ease of discussion it is helpful to introduce the following abbreviations:

- [30] = program 30, ..., [01] = program 1
- #4 = slot 4, ..., #1 = slot 1
- SNB = slot number button or its LED
- SNB#1 = slot number button of slot 1
- TOV = total overview
- IMV = info message view in TOV
- UCV = user calibration view in TOV
- SOV = slot operation view
- SPV = slot programming view
- GSV = global setup view
- DDV = diagram drawing view
- CC = constant current
- CV = constant voltage
- To depress = to long-press, to press and hold
- To click = to short-press, to press and release
- To press = to either click or depress, doesn't matter
- Empty slot = a slot with NO BATTERY, i.e. the SNB is black
- Ready slot = a slot with a blinking red-green SNB, i.e. ready to start the program
- Inactive slot = an empty or ready slot
- Busy slot = a slot with a solid red SNB, i.e. running a program
- Finished slot = a slot with a solid green SNB, i.e. finished the program normally
- Active slot = a busy or finished slot
- Electric charge transfer = either charge or discharge
- Routine = charging, discharging, or resting, as part of a program consisting of several such routines
- Operation mode = Charge, Discharge, Storage, Cycle, Refresh, or Break\_in
- Program = an operation mode tied to a full set of settings and with a program number assigned to it
- Program number = a program number is the program with this number, and not only the number itself
- To finish a slot or program = the busy slot becomes a finished slot
- To stop a slot or program = the active slot becomes a ready slot

# SPECIFICATIONS

Input Power	DC 11V ~ 18V / 60W	PSU adapter output specs
Circuit Power	max. Charge power 50W max. Discharge power  -15W	x =x, for x>0  x =-x, for x<0
Battery Count	1 ~ 4 single cells, cylindrical	4 independent slots
Battery Size	AAAA, AAA, AA, Sub-C, C, D**, 10340, 10350, 10440, 10500, 12340, 12500, 12650, 13450, 13500, 13650, 14350, 14430, 14500, 14650, 16340, RCR123, 16500, 16650, 17350, 17500, 17650, 17670, 18350, 18490, 18500, 18650, 18700, 20700, 21700, 22500, 22650, 25500, 26500, 26650, 32600**, 32650**	**2 cells can fit together with 2 other batteries
Operating Voltage Range	0.2V ~ 5.0V/slot	max. admissible voltage 5.0V!
Battery Chemistry Type	NiMH, NiCd, NiZn, Eneloop, Lithium-Ion, Lilo4.35, LiFePO4	discharge Alkaline or Zinc-Carbon with NiMH
Battery Capacity	100mAh ~ 50,000mAh	safety cut-off
UI Modes	≥2	Advanced, Simple, ...
Charge Current Range	0.05A ~ 3.00A/slot	0.01A increments
Charge Algorithm	NiMH/NiCd/Eneloop: CC w/ -dV LiXX/NiZn: CC-CV w/ TC	delta peak detection termination current
CV Termination Current	0.01A ~ 0.05A+	or lower ("Zero")
-dV Sensibility	0dV, or 1mV ~ 20mV	for NiMH/NiCd
Trickle Charge	0.01A ~ 0.05A+	for NiMH/NiCd
Discharge Current Range	-0.05A ~ -2.00A	-0.01A  increments
Discharge Reduce	-0.01A ~ -0.05A+	or lower ("-Zero")
Operation Modes	Charge, Discharge, Storage, Break_in, Refresh, Cycle	available selection depends on BATT TYPE
Cycle Count	1 ~ 99 cycles	
Cycle Modes	4	C>D, C>D>C, D>C, D>C>D
Rest Time	0min ~ 240min	C.RESTING vs. D.RESTING
Safety Timer	1min ~ 1440min total time	safety cut-off
Memory	30 global programs	neither more nor less
Display	128×64 LCD b/w	w/ background lighting
LED	5	slot number buttons, Bluetooth
Controls	via 8 buttons, PC Link, or BT 4.0	Bluetooth 4.0 is cool
Beep Sound Range	2	octaves

# PACKAGE CONTENTS

Temperature Sensors	2 for inner, 4 for outer measurements	electronics vs. battery slots
Battery Temperature	20°C ~ 70°C	safety cut-off (+ safety net)
Internal Temperature	85°C	safety net
Operating Temperature	0°C ~ 40°C	ventilated room
Calibration	Factory calibration, User calibration	can be reset
Reset	soft reset, hard reset	the latter undocumented
Voltage Measurement	±1mV internal resolution	≤0.1% accuracy at lab conditions
Current Measurement	±1mA internal resolution	≤0.1% accuracy at lab conditions
Standby Current Drain	<0.5mA/battery	ready slot
External Ports	DC Input, PC Link, USB power output	Micro-USB B for PC Link
USB Power Output	DC 5V / 2.1A	USB A-type
Firmware Update	Yes	via PC Link
Dimensions (L×W×H)	200×124×69mm	not so compact
Material	ABS casing, aluminum heatsink	w/ mini cooling fan
Weight	600g(approx.)	unplugged device

# PACKAGE CONTENTS

1. SkyRC MC3000 Charger
2. AC Switching Adaptor
3. Instruction Manual





# CONFORMITY DECLARATION

SKYRC MC3000 satisfies all relevant and mandatory CE directives and FCC SubPart C Intentional Radiators section 15.247

The product has been tested to meet the following technical standards:

	Test Standards	Title	Result
CE-R&TTE	EN 300328	Wideband transmission systems; Data transmission equipment operating in the 2,4 GHz ISM band and using wide band modulation techniques article 3.1(b) EMC requirements	Conform
	EN 301489-1	Electromagnetic compatibility and Radio spectrum Matters (ERM); ElectroMagnetic Compatibility (EMC) standard for radio equipment and services. Part 1: Common technical requirements	Conform
	EN 301489-17	Electromagnetic compatibility and Radio spectrum Matters (ERM); ElectroMagnetic Compatibility (EMC) standard for radio equipment and services. Part 17: Specific conditions for Broadband Data Transmission Systems article 3.1(a) Health requirements	Conform
	EN 62479	Assessment of the compliance of low power electronic and electrical equipment with the basic restrictions related to human exposure to electromagnetic fields (10 MHz to 300 GHz) article 3.1(a) Safety	Conform
FCC	FCC SubPart C Intentional Radiators section 15.247	Operation within the bands 902 - 928 MHz, 2400 - 2483.5 MHz, and 5725 - 5850 MHz.	Conform

## FCC Note

This device complies with Part 15 of the FCC Rules.

Operation is subject to the following two conditions: (1) this device may not cause harmful interference, and (2) this device must accept any interference received, including interference that may cause undesired operation.

THE MANUFACTURER IS NOT RESPONSIBLE FOR ANY RADIO OR TV INTERFERENCE CAUSED BY UNAUTHORIZED MODIFICATIONS TO THIS EQUIPMENT. SUCH MODIFICATIONS COULD VOID THE USER'S AUTHORITY TO OPERATE THE EQUIPMENT.

To maintain compliance with FCC's RF exposure guidelines, this equipment should be installed and operated with a minimum distance of 20cm between the radiator and your body.

Hereby, SKYRC Technology Co.,Ltd. declares that this [type of equipment AA/AAA NiMH/NiCd BATTERY CHARGER & ANALYZER is in compliance with the essential requirements and other relevant provisions of Directive 1999/5/EC.



This symbol means that you must dispose of electrical devices from the General household waste when it reaches the end of its useful life. Take your charger to your local waste collection point or recycling centre. This applies to all countries of the European Union, and to other European countries with a separate waste collection system.

# LIABILITY EXCLUSION & WARRANTY AND SERVICE

## Liability Exclusion

This charger is designed and approved exclusively for use with the types of battery stated in these instruction Manual. SKYRC accepts no liability of any kind if the charger is used for any purpose other than that stated. We are unable to ensure that you follow the instructions supplied with the charger, and we have no control over the methods you employ for using, operating and maintaining the device. For this reason we are obliged to deny all liability for loss, damage or costs which are incurred due to the incompetent or incorrect use and operation of our products, or which are connected with such operation in any way. Unless otherwise prescribed by law, our obligation to pay compensation, regardless of the legal argument employed, is limited to the invoice value of those SKYRC products which were immediately and directly involved in the event in which the damage occurred.

## Warranty and Service

We guarantee this product to be free of manufacturing and assembly defects for a period of one year from the time of purchase. The warranty only applies to material or operational defects, which are present at the time of purchase. During that period, we will repair or replace free of service charge for products deemed defective due to those causes.

This warranty is not valid for any damage or subsequent damage arising as a result of misuse, modification or as a result of failure to observe the procedures outlined in this manual.

The warranty service is valid in China only.

If you need warranty service overseas, please contact your dealer in the first instance, who is responsible for processing guarantee claims overseas. Due to high shipping cost, complicated custom clearance procedures to send back to China. Please understand SKYRC can't provide warranty service to overseas end user directly.

If you have any questions which are not mentioned in the manual, please feel free to send email to [info@skyrc.cn](mailto:info@skyrc.cn)