

# BRIGHT LED ELECTRONICS CORP.

## LED DISPLAY SPECIFICATION

●COMMODITY : 0.56"(14.20mm) SINGLE DIGIT LED DISPLAY

●DEVICE NUMBER : BS-A512RD

VERSION : 1.0 /2001.03.28

●ELECTRICAL AND OPTICAL CHARACTERISTICS (Ta=25°C)

Chip		Absolute Maximum Rating				Electro-optical Data (At 10mA)			Surface Color	Segment Color
Emitted Color	Peak Wave Length $\lambda P(\text{nm})$	$\Delta \lambda$ (nm)	Pd (Mw)	If (mA)	Peak If(mA)	Vf(V)		Iv Typ. (mcd)		
						Typ.	Max.			
Green	568	30	80	30	150	2.2	2.5	3.0	Black	White

●ABSOLUTE MAXIMUM RATINGS (Ta=25°C)

Reverse Voltage ..... 5V  
 Reverse Current (-Vr=5V) ..... 50 $\mu$ A  
 Operating Temperature Range ..... -40°C ~ 80°C  
 Storage Temperature Range ..... -40°C ~ 85°C  
 Lead Soldering Temperature (1/16" From Body).....260°C For 5 Seconds

### PACKAGE DIMENSIONS:

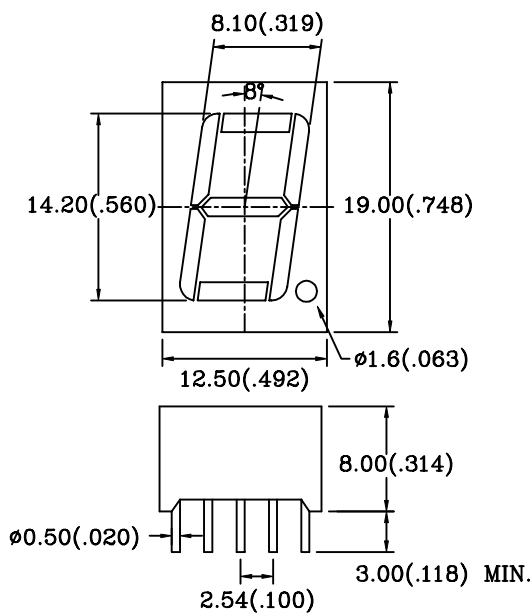

NOTES:  
 1.All dimensions are in millimeters(inches).  
 2.Tolerance is  $\pm 0.25\text{mm}(.01")$  unless otherwise specified.  
 3.Specifications are subject to change without notice.

### PIN FUNCTIONS:

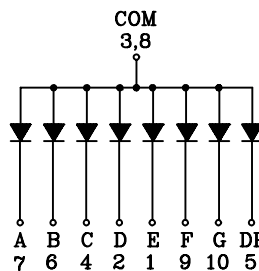
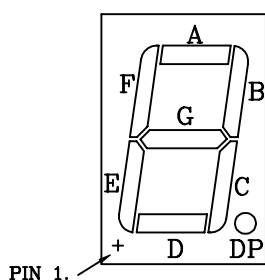

RELEASED:

曾  
2001.10.24  
志宏

ENGINEER:

余  
2001.10.24  
芳芳

# BRIGHT LED ELECTRONICS CORP.

## TYPICAL CHARACTERISTICS

DEVICE NUMBER: BS-A512RD

### SPECTRAL DISTRIBUTION

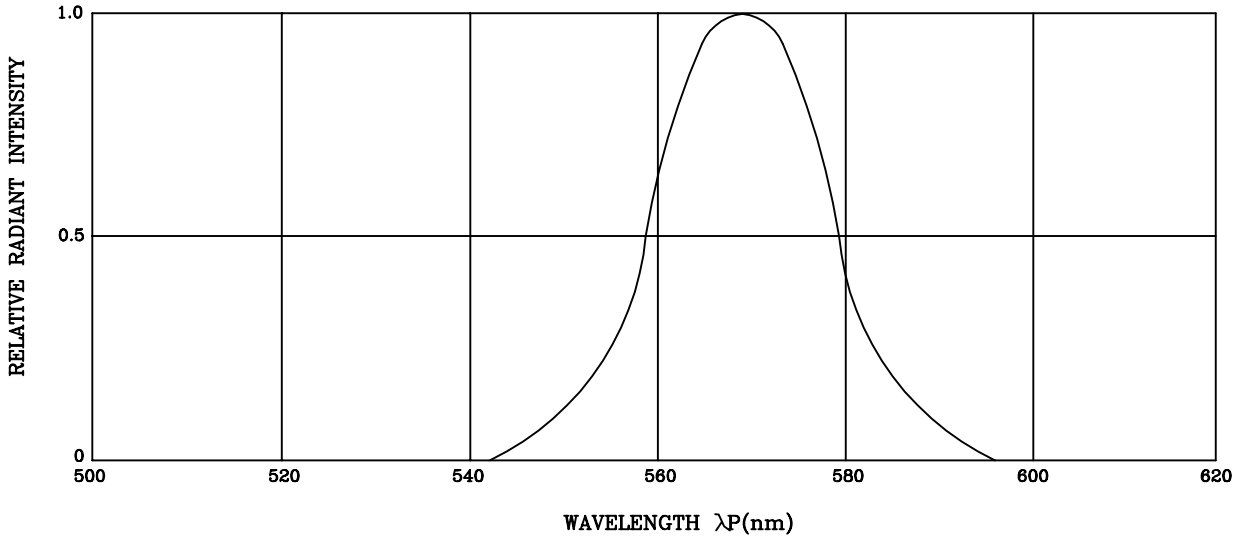

### FORWARD CURRENT VS. FORWARD VOLTAGE

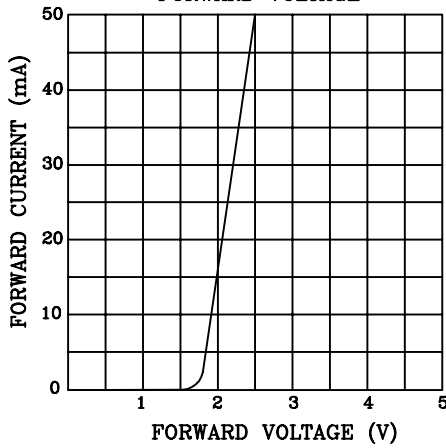

### RELATIVE LUMINOUS INTENSITY VS. AMBIENT TEMPERATURE

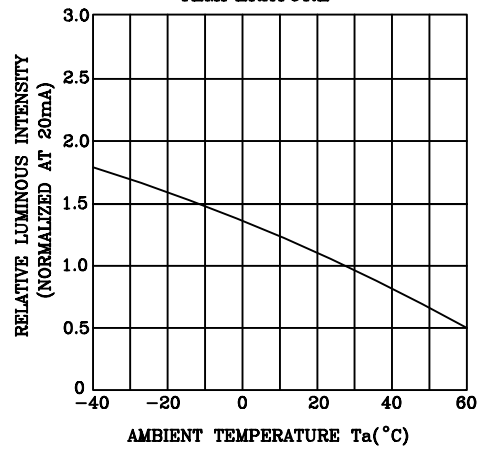

### RELATIVE LUMINOUS INTENSITY VS. FORWARD CURRENT

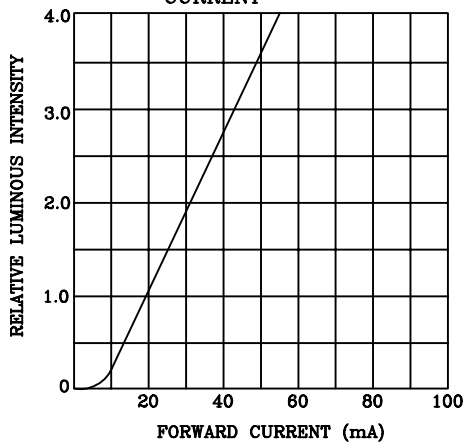

### FORWARD CURRENT DERATING CURVE

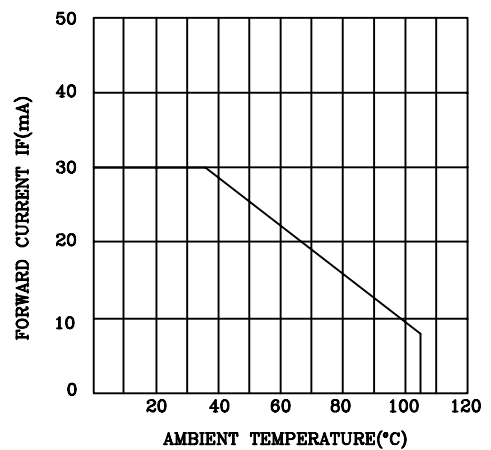

# RELIABILITY TEST

**DEVICE NO.: BS-A512RD**

Classification	Test Item	Reference Standard	Test Conditions	Result
Endurance Test	Operation Life	MIL-STD-750:1026 MIL-STD-883:1005 JIS C 7021 :B-1	Connect with a power $I_f=25\text{mA}$ $T_a$ =Under room temperature Test time=1,000hrs(-24hrs,+72hrs)	0/10
	High Temperature High Humidity Storage	MIL-STD-202:103B JIS C 7021 :B-11	$T_a=65^\circ\text{C}\pm 5^\circ\text{C}$ RH=90%-95% Test time=240hrs $\pm$ 2hrs	0/10
	High Temperature High Humidity Reverse Bias		$T_a=65^\circ\text{C}\pm 5^\circ\text{C}$ RH=90%-95% Test time=500hrs(-24hrs,+48hrs)	0/10
	High Temperature Storage	MIL-STD-883:1008 JIS C 7021 :B-10	High $T_a=85^\circ\text{C}\pm 5^\circ\text{C}$ Test time=1,000hrs(-24hrs,+72hrs)	0/10
	Low Temperature Storage	JIS-C-7021 :B-12	Low $T_a=-35^\circ\text{C}\pm 5^\circ\text{C}$ Test time=1,000hrs(-24hrs,+72hrs)	0/10
Environmental Test	Temperature Cycling	MIL-STD-202:107D MIL-STD-750:1051 MIL-STD-883:1010 JIS C 7021 :A-4	$-35^\circ\text{C} \sim 25^\circ\text{C} \sim 85^\circ\text{C} \sim 25^\circ\text{C}$ 30min 5min 30min 5min Test Time=10cycle	0/10
	Thermal Shock	MIL-STD-202:107D MIL-STD-750:1051 MIL-STD-883:1011	$85^\circ\text{C}\pm 5^\circ\text{C} \sim -35^\circ\text{C}\pm 5^\circ\text{C}$ 10min 10min Test Time=10cycle	0/10
	Solder Resistance	MIL-STD-202:201A MIL-STD-750:2031 JIS C 7021 :A-1	$T_{\text{sol}}=260\pm 5^\circ\text{C}$ Dwell Time=10 $\pm$ 1sec.	0/10
	Solderability	MIL-STD-202:208D MIL-STD-750:2026 MIL-STD-883:2003 JIS C 7021 :A-2	$T_{\text{sol}}=230\pm 5^\circ\text{C}$ Dwell Time=5 $\pm$ 1sec.	0/10

## JUDGMENT CRITERIA OF FAILURE FOR THE RELIABILITY

Measuring items	Symbol	Measuring conditions	Judgement criteria for failure
Forward voltage	VF	$I_F=20\text{mA}$	Over $U_x1.2$
Reverse current	IR	$V_R=5\text{V}$	Over $U_x2$
Luminous intensity	IV	$I_F=20\text{mA}$	Below $S_x0.5$

Note: 1.U means the upper limit of specified characteristics. S means initial value.

2.Measurment shall be taken between 2 hours and after the test pieces have been returned to normal ambient conditions after completion of each test.