



62783

LINEAR INTEGRATED CIRCUIT

8CH HIGH-VOLTAGE SOURCE DRIVER

DESCRIPTION

The UTC 62783 consists of eight source current transistor array combination and it is suitable for fluorescent display applications.

The UTC 62783 is ideal for uses, such as relay, hammer and lamp drivers.

FEATURES

- *High output voltage: $V_{CC} = 50V$ (MIN.)
- * Output current (single output) $I_{OUT} = -500mA$ (MIN.)
- * Output clamp diodes and single supply voltage
- * Input compatible with various types of logic
- * TTL, 5V CMOS

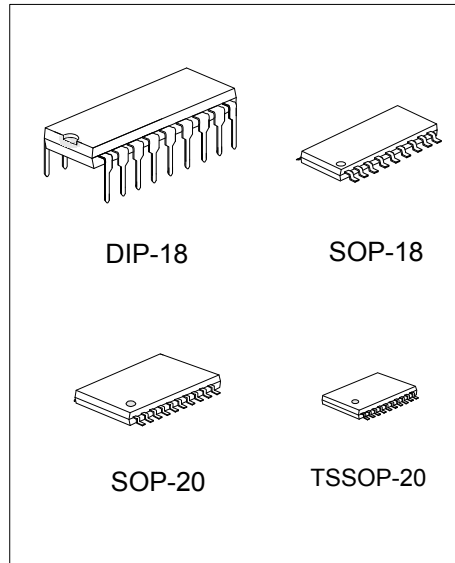

ORDERING INFORMATION

Ordering Number		Package	Packing
Lead Free	Halogen Free		
62783L-D18-T	62783G-D18-T	DIP-18	Tube
62783L-S18-R	62783G-S18-R	SOP-18	Tape Reel
62783L-S20-R	62783G-S20-R	SOP-20	Tape Reel
62783L-P20-R	62783G-P20-R	TSSOP-20	Tape Reel

<p>62783G-D18-T</p> <p>(1)Packing Type (2)Package Type (3)Green Package</p>	<p>(1) T: Tube, R: Tape Reel (2) D18: DIP-18, S18: SOP-18, S20: SOP-20 P20: TSSOP-20 (3) G: Halogen Free and Lead Free, L: Lead Free</p>
---	--

MARKING

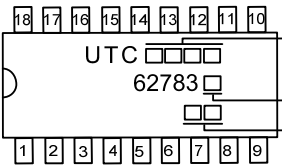
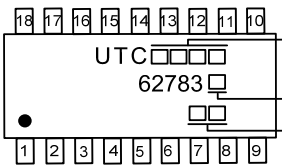
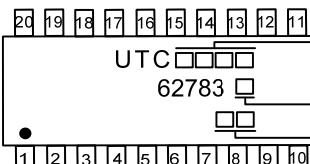
Packing	MARKING
DIP-18	 <p> 18 17 16 15 14 13 12 11 10 → Date Code UTC □□□□ → L: Lead Free 62783 □ → G: Halogen Free □□ → Lot Code 1 2 3 4 5 6 7 8 9 </p>
SOP-18	 <p> 18 17 16 15 14 13 12 11 10 → Date Code UTC □□□□ → L: Lead Free 62783 □ → G: Halogen Free □□ → Lot Code 1 2 3 4 5 6 7 8 9 </p>
SOP-20 TSSOP-20	 <p> 20 19 18 17 16 15 14 13 12 11 → Date Code UTC □□□□ → L: Lead Free 62783 □ → G: Halogen Free □□ → Lot Code 1 2 3 4 5 6 7 8 9 10 </p>

■ PIN CONFIGURATION

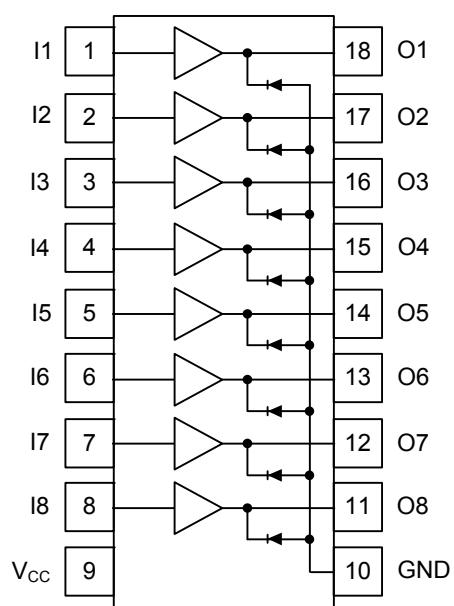

DIP-18/SOP-18

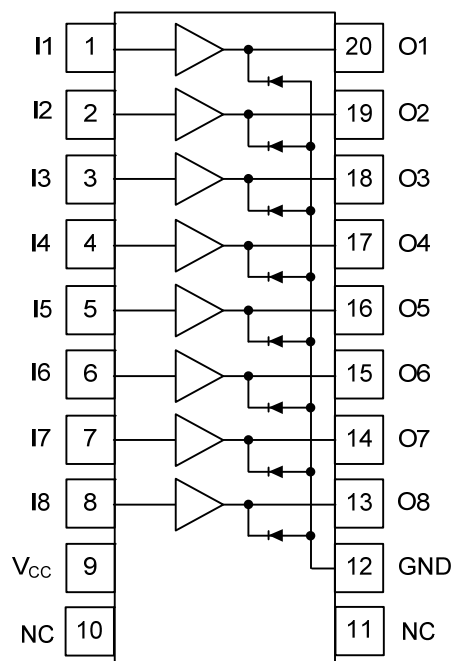

SOP-20

■ PIN DESCRIPTION

PIN NO.		PIN NAME	DESCRIPTION
DIP-18/ SOP-18	SOP-20		
1	1	I1	Input Of CH1
2	2	I2	Input Of CH2
3	3	I3	Input Of CH3
4	4	I4	Input Of CH4
5	5	I5	Input Of CH5
6	6	I6	Input Of CH6
7	7	I7	Input Of CH7
8	8	I8	Input Of CH8
9	9	V _{CC}	Power Supply
10	12	GND	Ground
11	13	O8	Output Of CH8
12	14	O7	Output Of CH7
13	15	O6	Output Of CH6
14	16	O5	Output Of CH5
15	17	O4	Output Of CH4
16	18	O3	Output Of CH3
17	19	O2	Output Of CH2
18	20	O1	Output Of CH1
-	10, 11	NC	Not connected

■ SCHEMATICS (EACH DRIVER)

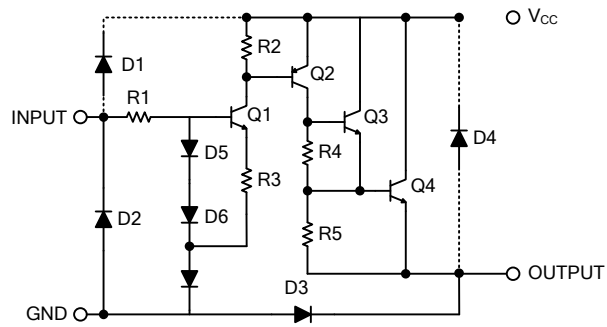

R1	R2	R3	R4	R5
10kΩ	20kΩ	2.6kΩ	10kΩ	5kΩ

Note: The input and output parasitic diodes (D1 & D4) cannot be used as clamp diodes

■ ABSOLUTE MAXIMUM RATING ($T_A = 25^\circ\text{C}$, unless otherwise specified)

PARAMETER	SYMBOL	RATINGS	UNIT
Supply Voltage	V_{CC}	50	V
Input Voltage	V_{IN}	15	V
Clamp Diode Reverse Voltage	V_R	50	V
Output Current	I_{OUT}	-500	mA/ch
Clamp Diode Forward Current	I_F	500	mA
Power Dissipation	DIP-18	1470	mW
	SOP-18/SOP-20	960	
	TSSOP-20	860	
Derated Above 25°C		7.7	mW/ $^\circ\text{C}$
Operating Temperature	T_{OPR}	-40 ~ +85	$^\circ\text{C}$
Storage Temperature	T_{STG}	-55 ~ +150	$^\circ\text{C}$

Note: Absolute maximum ratings are those values beyond which the device could be permanently damaged. Absolute maximum ratings are stress ratings only and functional device operation is not implied.

■ RECOMMENDED OPERATING CONDITIONS ($T_A = -40 \sim +80^\circ\text{C}$)

PARAMETER	SYMBOL	TEST CONDITIONS	MIN	TYP	MAX	UNIT
Supply Voltage	V_{CC}				50	V
Output Current	I_{OUT}	$T_A=85^\circ\text{C}$, $T_J=120^\circ\text{C}$, $T_p=25\text{ms}$	Duty=10%		-180	mA/ch
			Duty=50%		-38	mA/ch
Input Voltage	V_{IN}				12	V
Input Voltage	Output On	$V_{IN(ON)}$	2.0	5.0	15	V
	Output Off	$V_{IN(OFF)}$	0		0.8	V
Clamp Diode Reverse Voltage	V_R				35	V
Clamp Diode Forward Current	I_F				400	mA

■ ELECTRICAL CHARACTERISTICS ($T_A = 25^\circ\text{C}$)

PARAMETER	SYMBOL	TEST CIRCUIT	TEST CONDITIONS	MIN	TYP	MAX	UNIT
Output Leakage Current	I_{CEX}	1	$V_{CC} = V_{CC(MAX)}$, $V_{IN} = 0.4\text{V}$			100	μA
Output Saturation Voltage	$V_{CE(SAT)}$	2	$V_{IN} = V_{IN(ON)}$, $I_{OUT} = -350\text{mA}$			2.0	V
			$V_{IN} = V_{IN(ON)}$, $I_{OUT} = -225\text{mA}$			1.9	V
			$V_{IN} = V_{IN(ON)}$, $I_{OUT} = -100\text{mA}$			1.8	V
Input Current	$I_{IN(ON)}$	3	$V_{IN} = 2.4\text{V}$		36	52	μA
			$V_{IN} = 3.85\text{V}$		180	260	μA
Supply Current	$I_{CC(ON)}$	3	$V_{IN} = V_{IN(ON)}$, $V_{CC} = 50\text{V}$			3.5	mA/ch
Input Voltage	$V_{IN(ON)}$	4	$V_{CE} = 2.0\text{V}$			2.0	V
	$V_{IN(OFF)}$		$I_{OUT} = -500\mu\text{A}$	0.8			V
Clamp Diode Reverse Current	I_R	5	$V_R = 50\text{V}$			50	μA
Clamp Diode Forward Voltage	V_F	6	$I_F = 350\text{mA}$			2.0	V
Turn-On Delay	t_{ON}	7	$V_{CC} = V_{CC(MAX)}$, $R_L = 125\Omega$ $C_L = 15\text{pF}$		0.15		μs
Turn-Off Delay	t_{OFF}				7		μs

■ TEST CIRCUITS

1. I_{CEX}

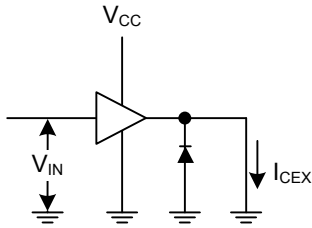

2. $V_{CE(SAT)}$

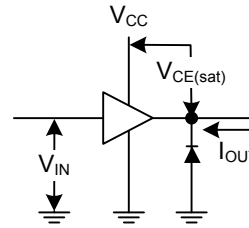

3. $I_{IN(ON)}, I_{CC}$

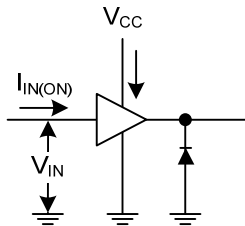

4. $V_{IN(ON)}, V_{IN(OFF)}$

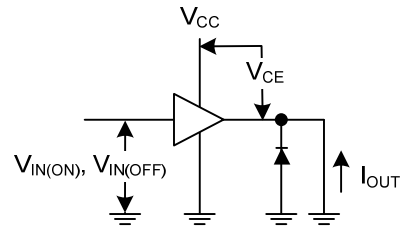

5. I_R

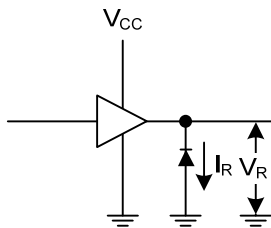

6. V_F

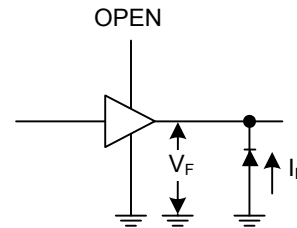

7. t_{ON}, t_{OFF}

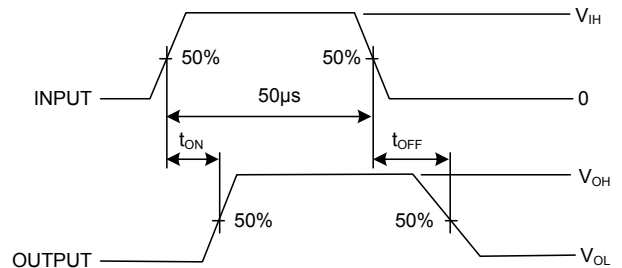
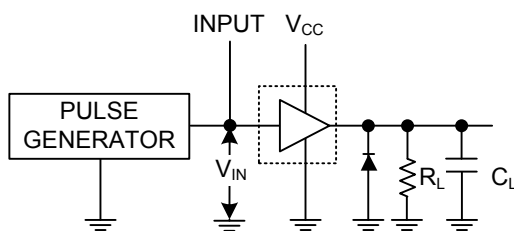

■ PRECAUTIONS FOR USING

This circuit does not integrate protection circuits such as over-current and overvoltage protectors.

Thus, the IC may be damaged if excess current or voltage is occurred to the IC. Make sure the IC design is fine so that excess current or voltage will not be applied to the IC.

You must take extreme care to the design of the output line, V_{CC} and GND line because IC may be destroyed under the condition of short-circuit between outputs, air contamination fault, or fault by improper grounding.

UTC assumes no responsibility for equipment failures that result from using products at values that exceed, even momentarily, rated values (such as maximum ratings, operating condition ranges, or other parameters) listed in products specifications of any and all UTC products described or contained herein. UTC products are not designed for use in life support appliances, devices or systems where malfunction of these products can be reasonably expected to result in personal injury. Reproduction in whole or in part is prohibited without the prior written consent of the copyright owner. UTC reserves the right to make changes to information published in this document, including without limitation specifications and product descriptions, at any time and without notice. This document supersedes and replaces all information supplied prior to the publication hereof.