

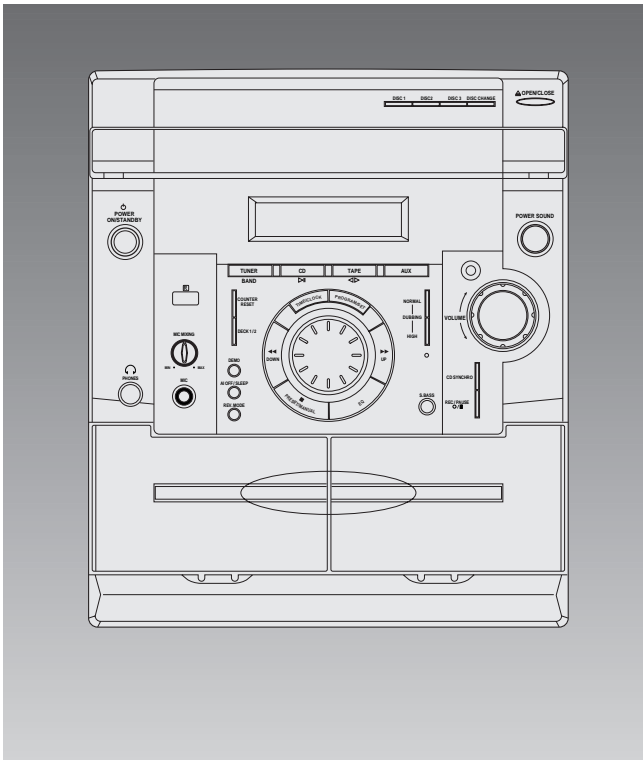

3 CD CHANGER MINI MINI COMPONENT MAX-909/910/916/929/930/932(P) MAX-936/938/939/940/941

SERVICE Manual

MIMI MIMI COMPONENT SYSTEM



CONTENTS

1. Alignment and Adjustments
2. Exploded Views and Parts List
3. Electrical Parts List
4. Block Diagrams
5. PCB Diagrams
6. Wiring Diagram
7. Schematic Diagrams

7. Schematic Diagram

7-1 CD Part(COMMON)

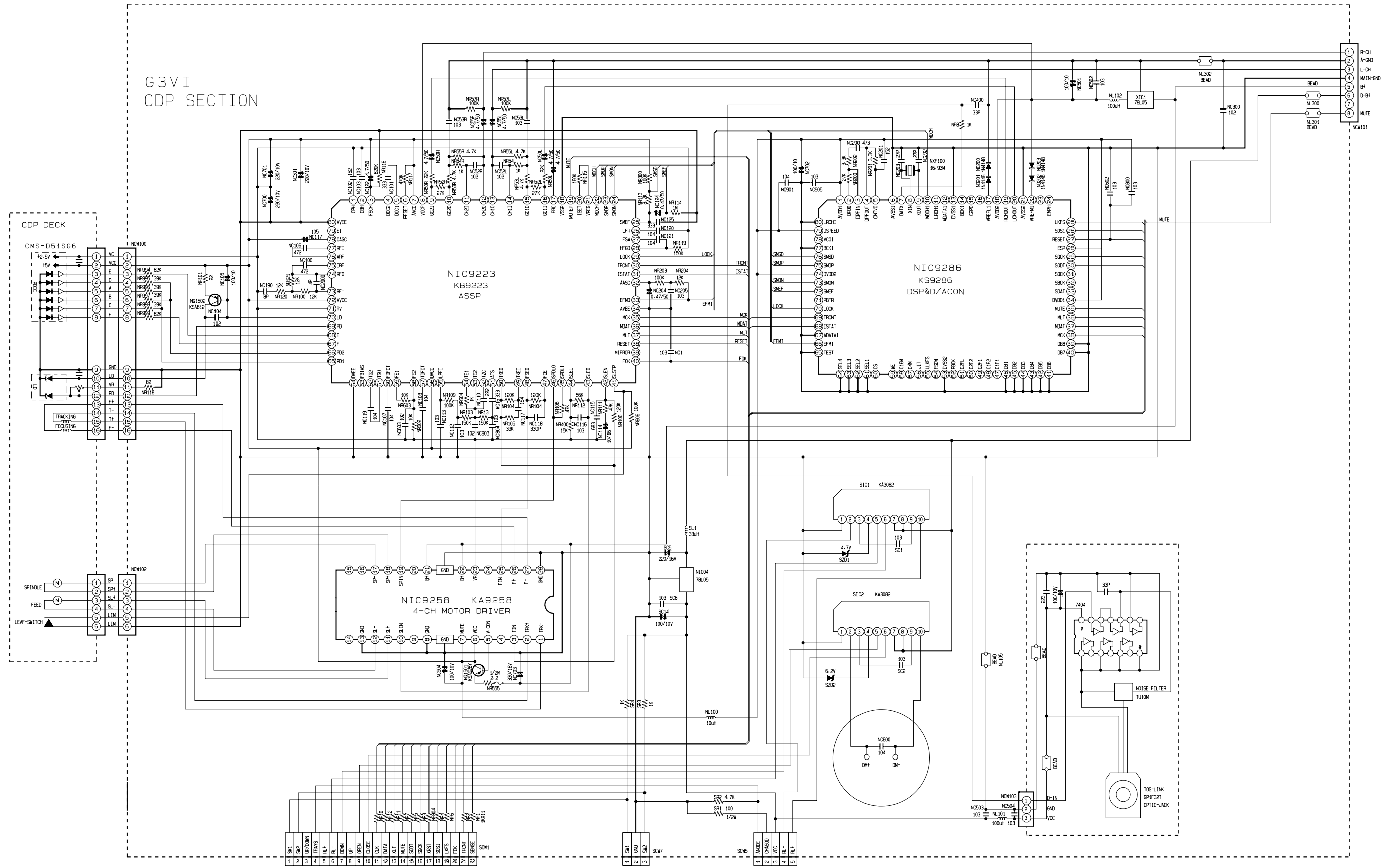

7-2 MAIN Part(COMMON)

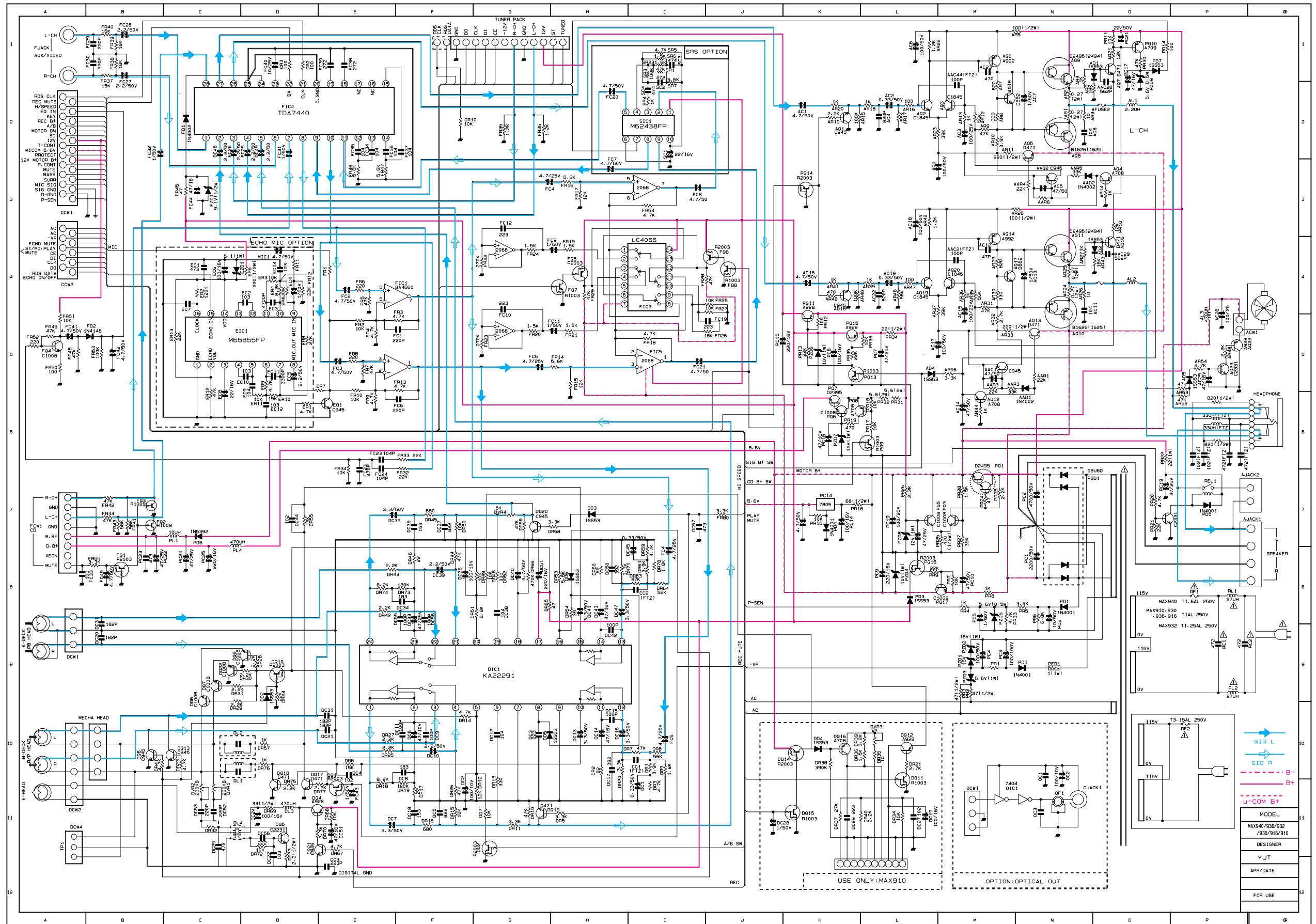

7-3 Front Part(Only MAX929/930/936/939/940/932P/942P)

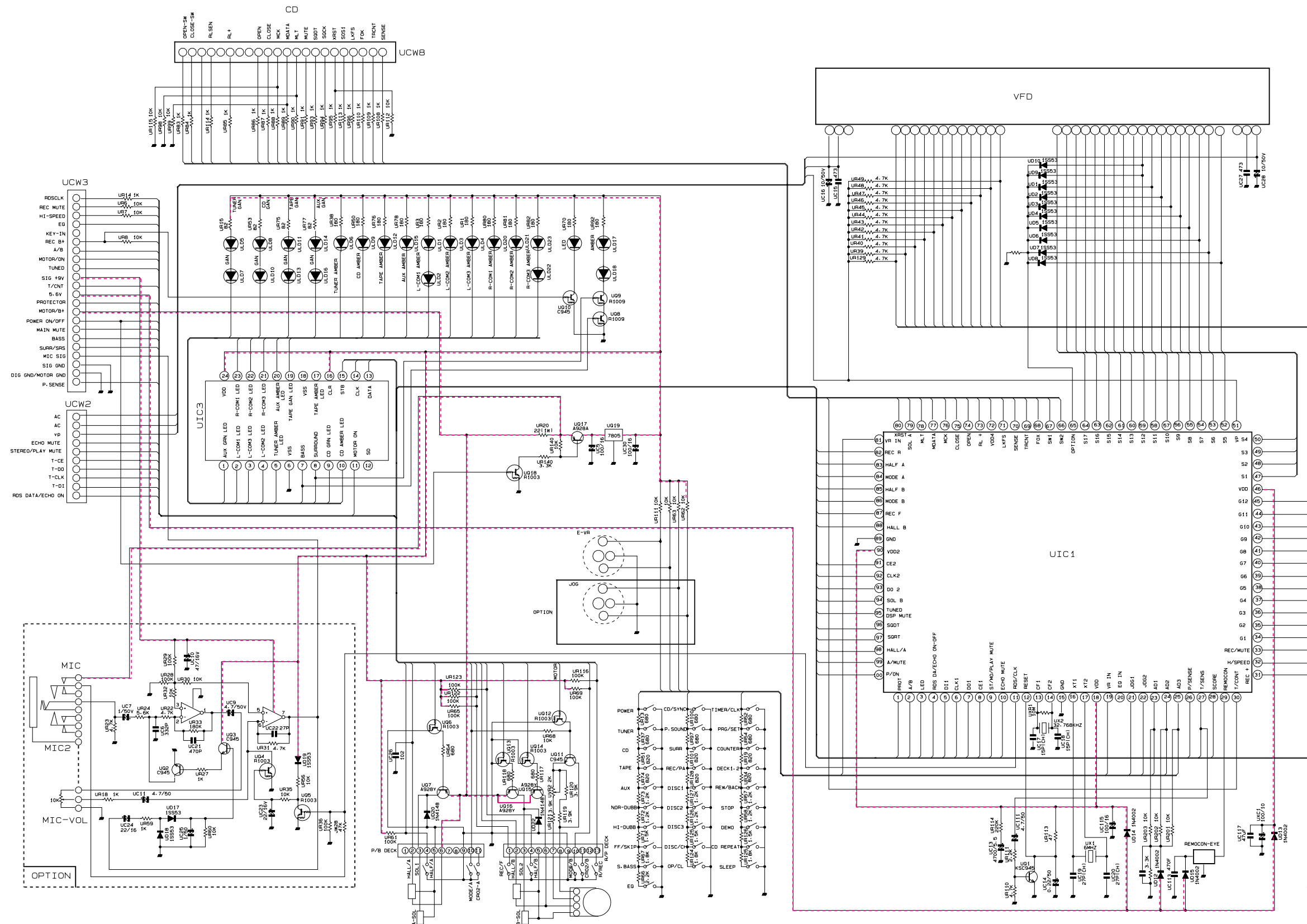

MAX940/936/932/930
FRONT PCB CIRCUIT

7-4 Front part2(Only MAX909/910/916)

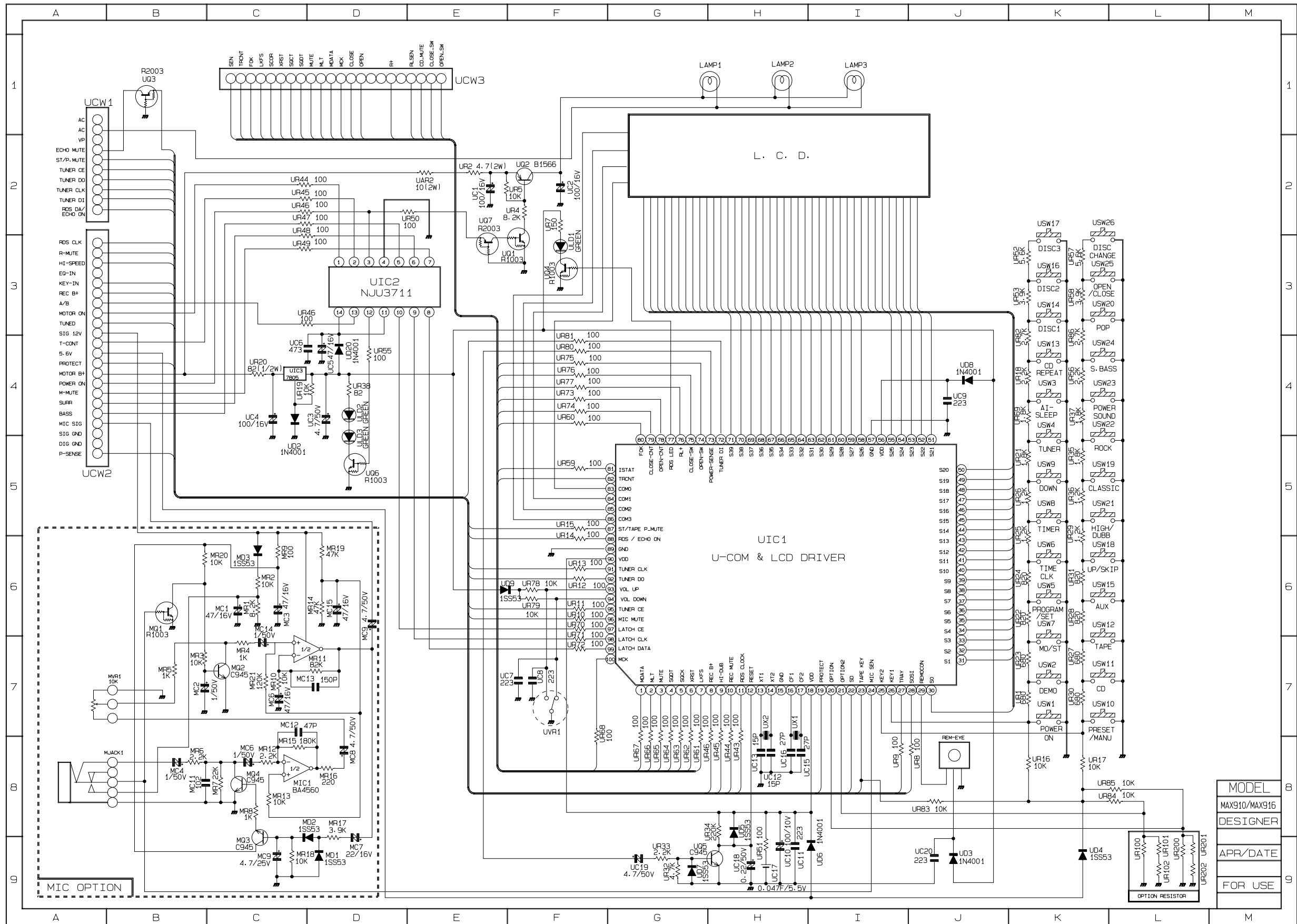

MODEL	MAX910/MAX916
DESIGNER	
APR/DATE	
FOR USE	

7-5 Pro Logic part(Only MAX932P/942P)

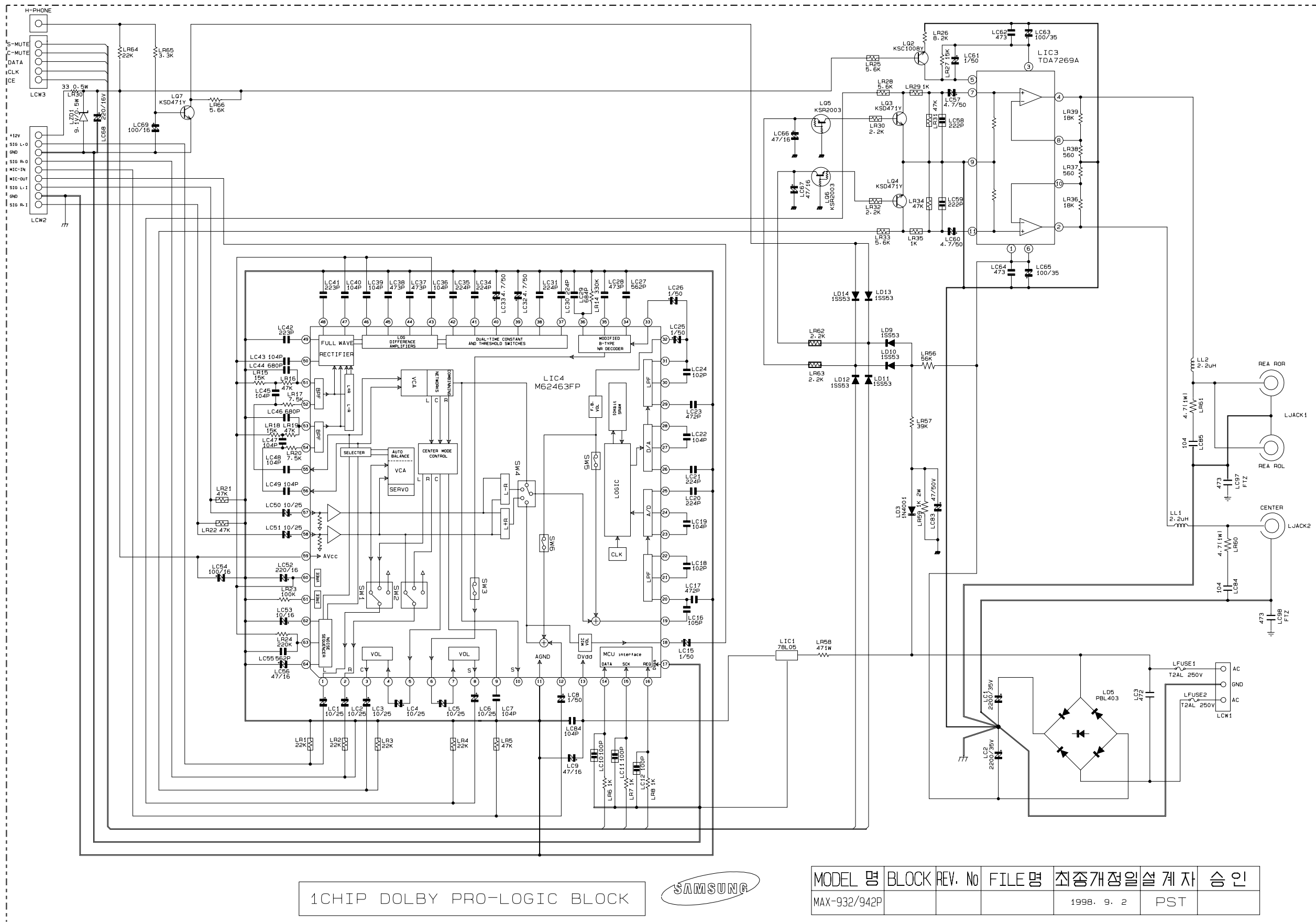

1CHIP DOLBY PRO-LOGIC BLOCK



MODEL 명	BLOCK	REV. No	FILE 명	최종개정일	설계자	승인
MAX-932/942P				1998. 9. 2	PST	

7-6 TUNER(COMMON)

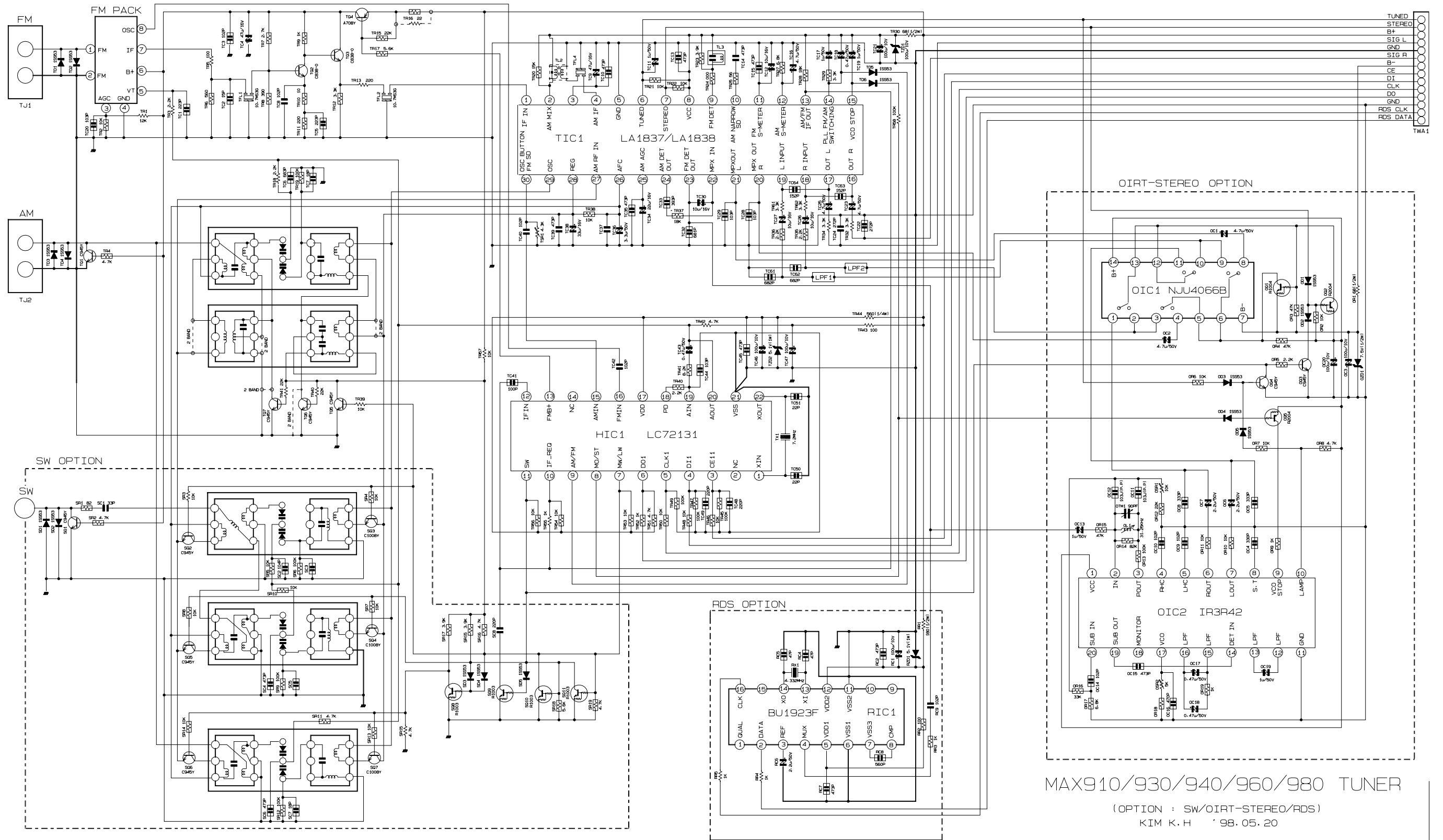

MAX910/930/940/960/980 TUNER

(OPTION : SW/OIRT-STEREO/RDS)
KIM K. H '98.05.20