

KENWOOD
HI/FI STEREO COMPONENTS

SERVICE MANUAL

KA-405 (KA-4055)

An item of adjustment is written in three languages — English, French and German.

Un article sur réglages est écrit en trois langues, Anglais, Français et Allemand.

Ein Artikel der Abgleich wird auf drei Sprachen, Englische, Französisch und Deutsch geschrieben.

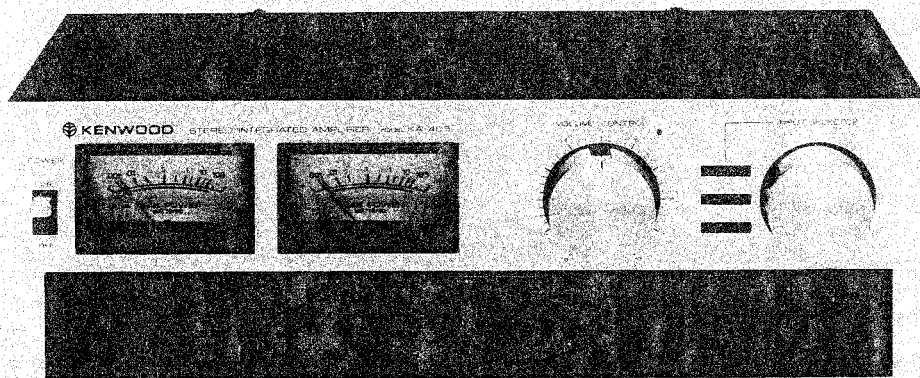

STEREO INTEGRATED AMPLIFIER

CONTENTS

- EXTERNAL VIEW 3
- INTERNAL VIEW 4
- BLOCK & LEVEL DIAGRAM 4
- DISASSEMBLY FOR REPAIR 5
- EXPLODED VIEW 6
- EXPLODED VIEW PARTS LIST 7
- ADJUSTMENT
 - ADJUSTMENT 8
 - RÉGLAGES 8
 - ABGLEICH 8
- SEMICONDUCTOR SUBSTITUTIONS 9
- PC BOARD 9
- SCHEMATIC DIAGRAM 11
- SPECIFICATIONS 11
- PARTS LIST 12

Note:

Component and circuitry are subject to modification to insure best operation under differing local conditions. This manual is based on the U.S. (K) standard, and provides information on regional circuit modification through use of alternate schematic diagrams, and information on regional component variations through use of parts list.

Region	Code
U.S.A	K
Canada	P
PX	U
Australia	X
Europe & Scandinavia (KA-405)	E1
Europe & Scandinavia (KA-4055)	E2
England (KA-405)	T1
England (KA-4055)	T2
Other Areas (KA-405)	M1
Other Areas (KA-4055)	M2
Audio Club (KA-4055)	H

EXTERNAL VIEW

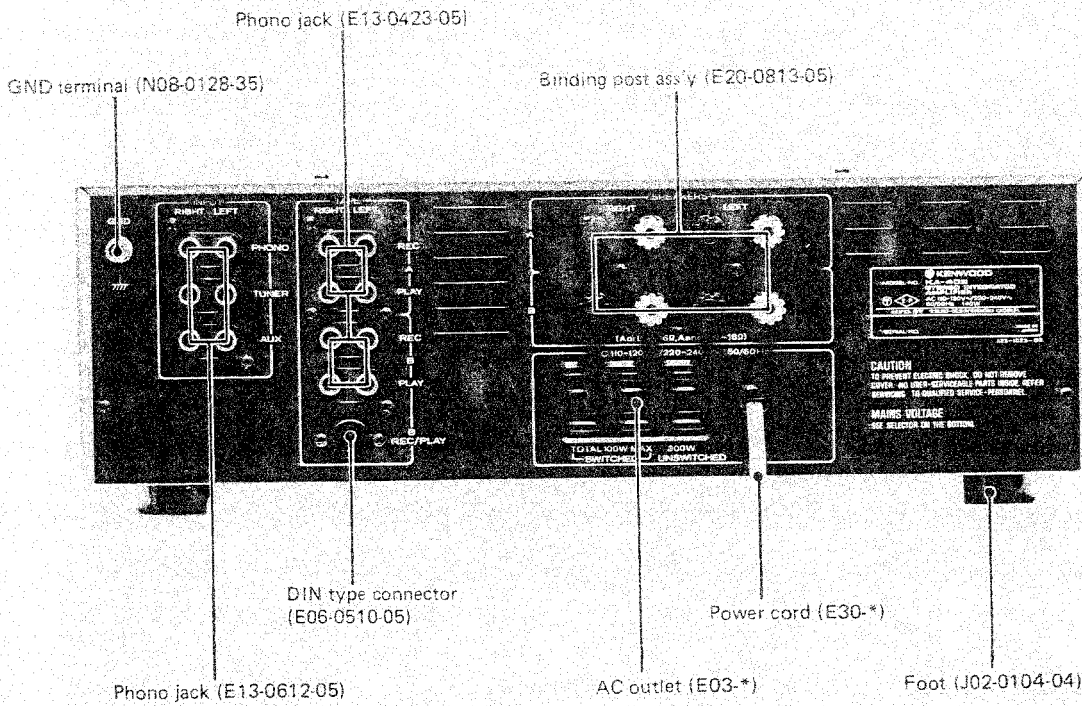
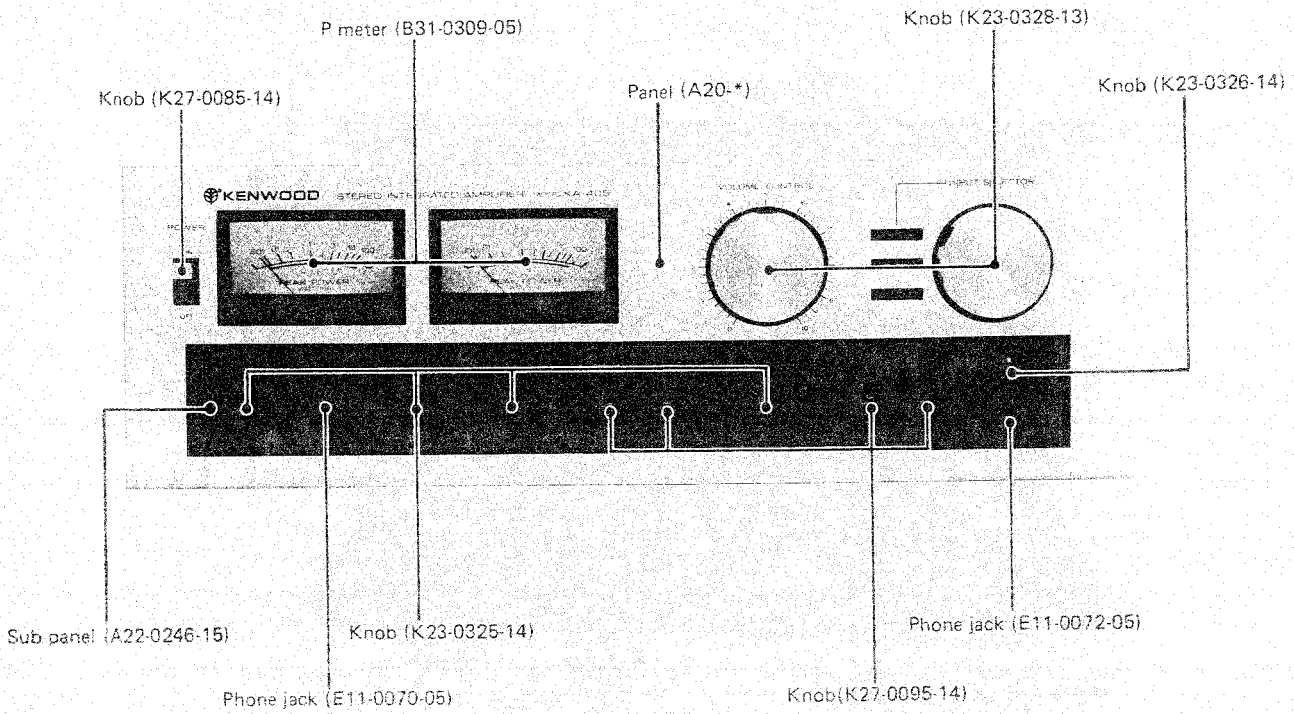

* Refer to Parts List

INTERNAL VIEW/BLOCK & LEVEL DIAGRAM

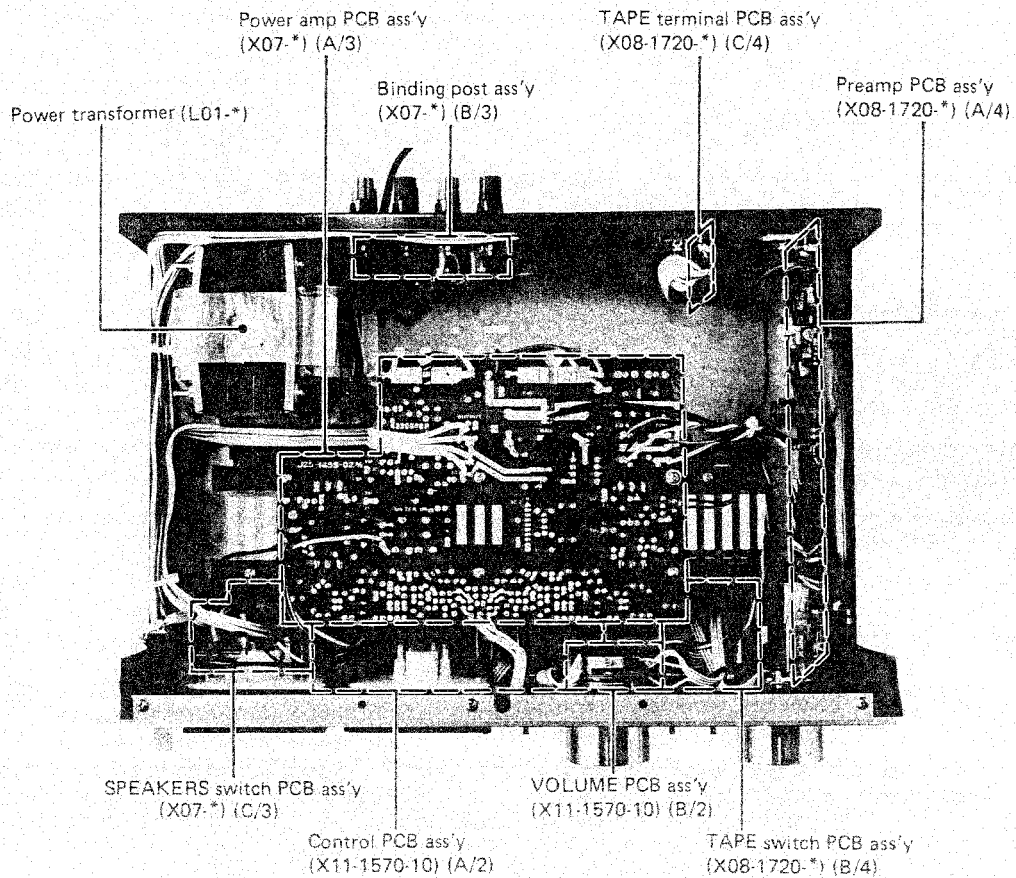

* Refer to Parts List

BLOCK & LEVEL DIAGRAM

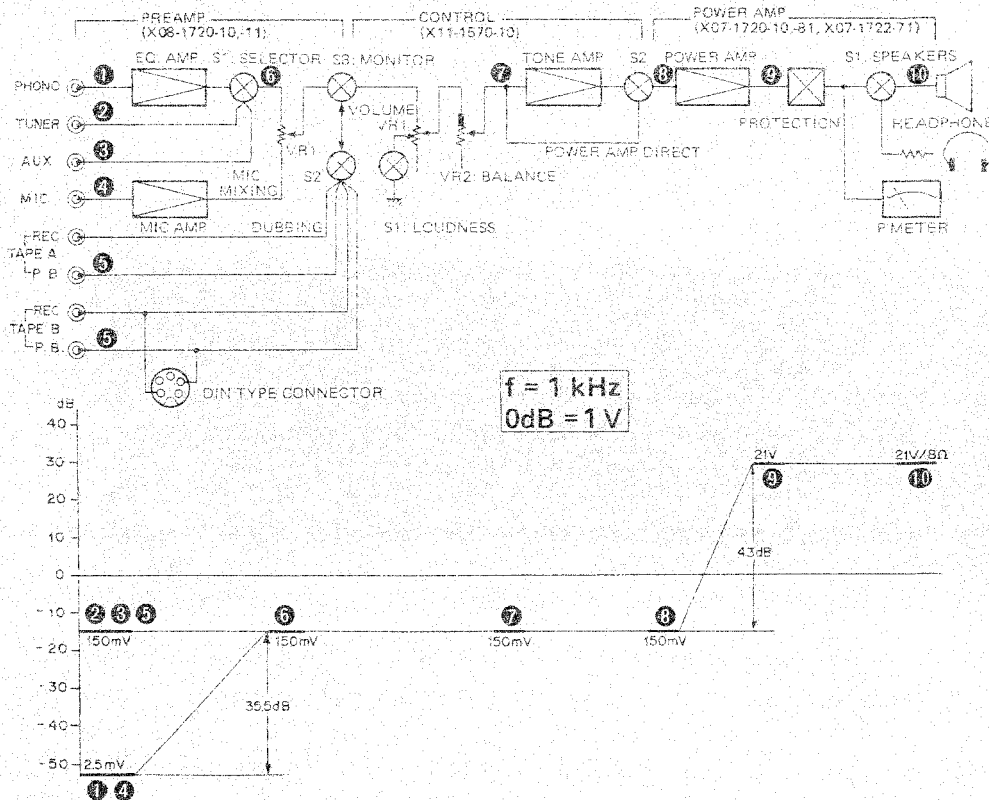

DISASSEMBLY FOR REPAIR

When removing the case, refer to EXPLODED VIEW.

POWER AMP

1. Remove the screws fixing the heat sinks to the chassis from bottom plate. Shown as ①.
2. Turn the power amp block (including heat sink) as figure.

CONTROL AND Switch PCB ass'y

1. Remove the screws fixing the PCB to the chassis. Shown as ②.
2. Pull out the knobs (SELECTOR and MIC MIXING) and remove the nut of INPUT SELECTOR. Shown as ③.
3. Remove the screws fixing panel to chassis. Shown as ④ and ⑤.
4. Turn the panel ass'y up.

Remove P meter

Push the meter with expanding the projection of sub panel.

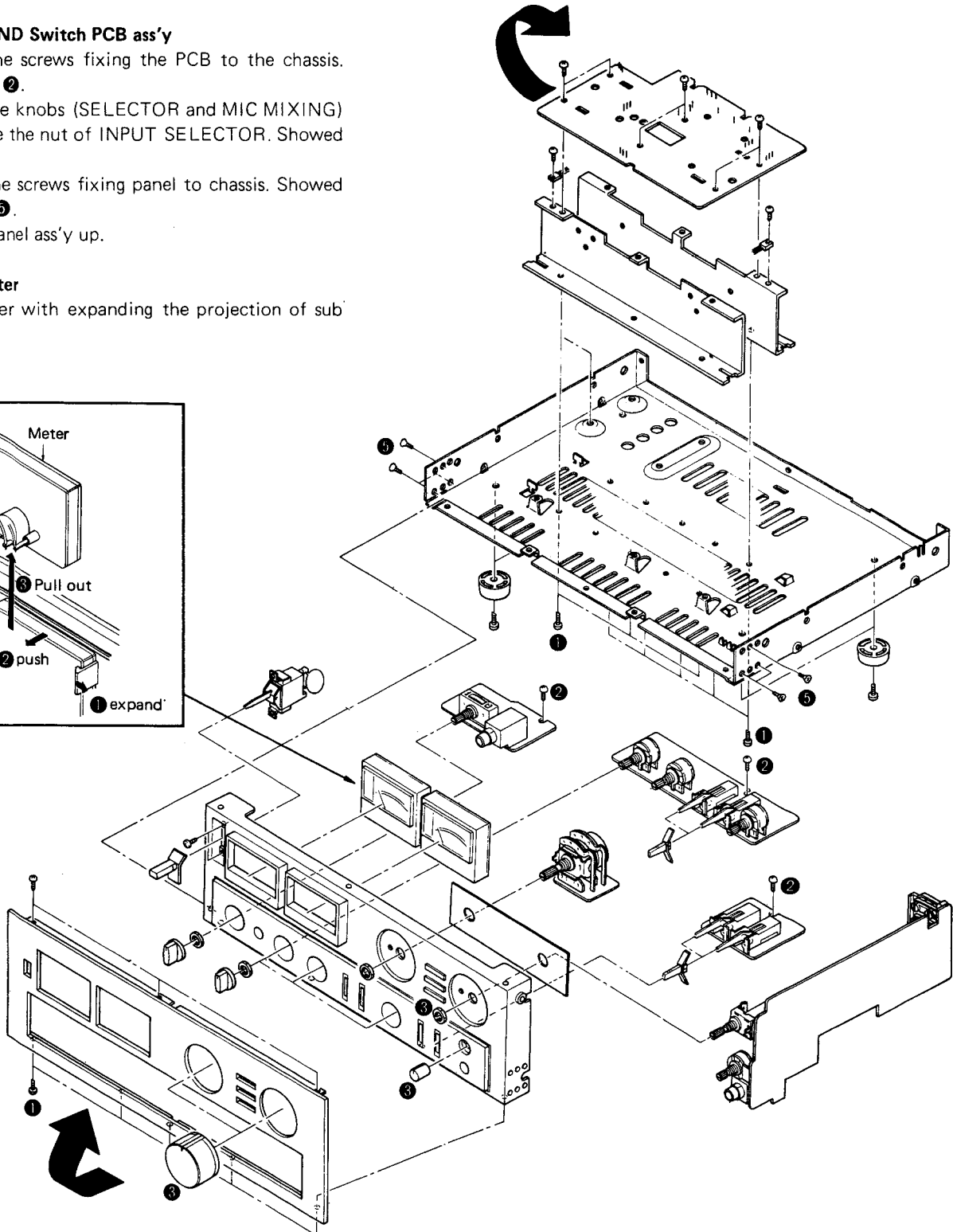
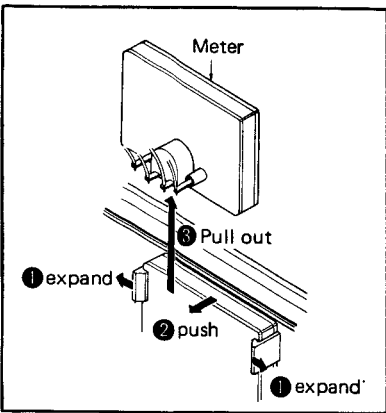

EXPLODED VIEW

A

B

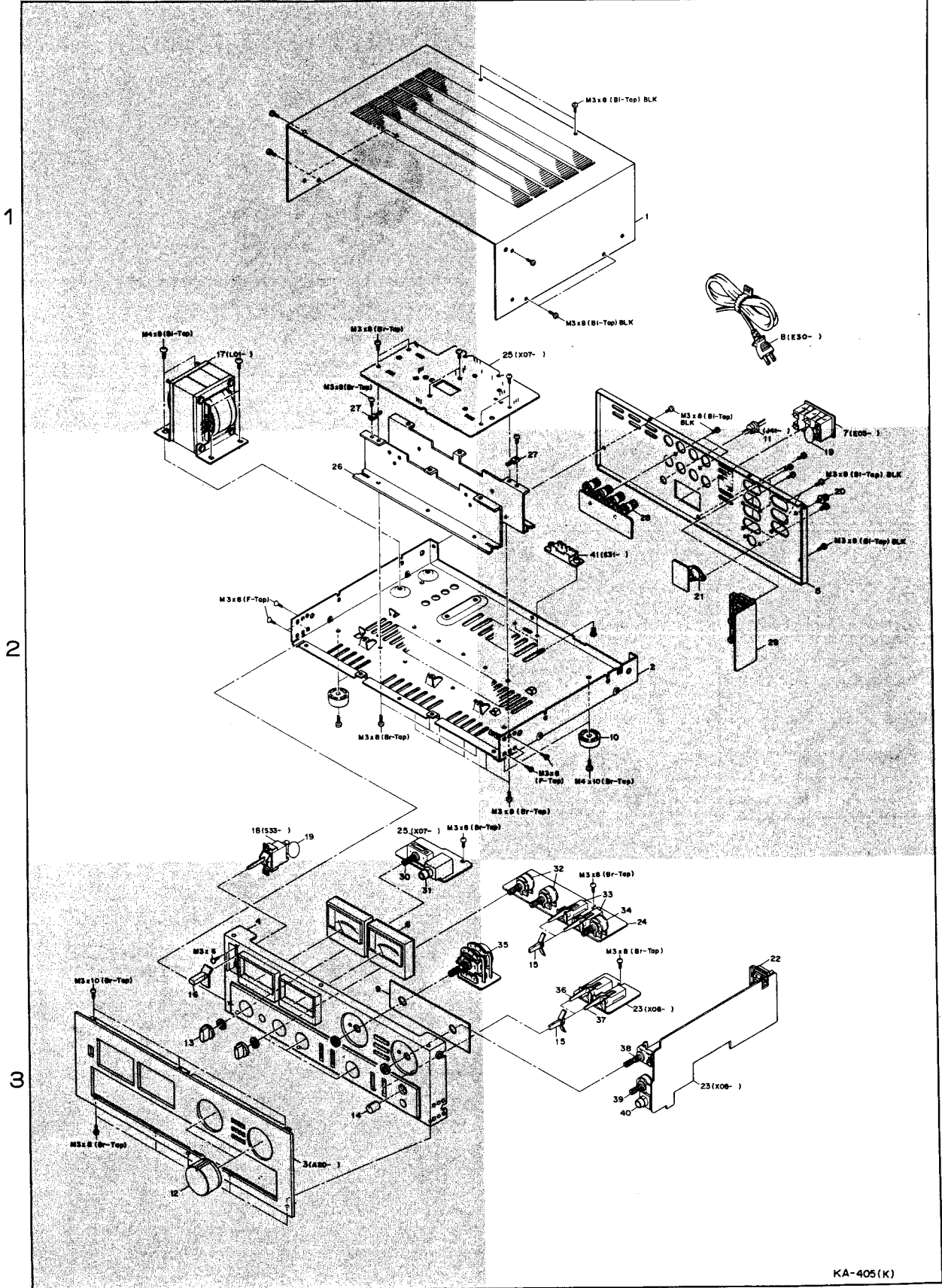

EXPLODED VIEW PARTS LIST

*: Refer to Parts List. ☆: New Parts.

Fig. No.	Parts No.	Description	Remarks
1	A01-0355-03	Case	☆ 1B
2	—	Chassis	2B
3	A20-*	Panel	☆ 3A
4	A22-0246-15	Sub panel	3A
5	—	Rear panel	2B
6	B31-0309-05	P meter	☆ 3A
7	E03-*	AC outlet	2B
8	E30-*	Power cord	1B
9	—	Reinforce	3A
10	J02-0049-14	Foot	2B
11	J41-*	Power cord bushing	2B
12	K23-0328-13	Knob (VOLUME, SELECTOR)	☆ 3A
13	K23-0325-14	Knob (TONE, BALANCE, SPEAKERS)	☆ 3A
14	K23-0326-14	Knob (MIC)	☆ 3A
15	K27-0095-14	Knob (Lever)	☆ 3B
16	K27-0085-14	Knob (POWER)	3A
17	L01-*	Power transformer	☆ 1A
18	S33-*	Lever switch (POWER)	2A
19	*	Ceramic cap.	2A, 2B
20	N08-0128-35	GND terminal screw	2B
21	E06-0510-05	DIN type connector	2B
22	E13-0612-05	Phono jack (6P)	3B
23	X08-1720-*	Preamp PCB ass'y	☆ 3B
24	X11-1570-10	Control PCB ass'y	☆ 3B
25	X07-*	Power amp PCB ass'y	☆ 1B, 2A
26	—	Heat sink	2A
27	V11-5100-40	Varistor STV-4H (G)	1A, 2B
28	E20-0813-05	Binding post ass'y	2B
29	E13-0423-05	Phono jack (TAPE)	☆ 2B
30	S29-1120-05	Rotary-slide switch (SPEAKERS)	☆ 3A
31	E11-0072-05	Phone jack (HEADPHONE)	☆ 3A
32	R06-3019-05	Potentiometer 20 k Ω (B) (TONE)	☆ 3B
33	S33-2055-05	Lever switch (LOUDNESS, POWER AMP DIRECT)	☆ 3B
34	R06-5042-05	Potentiometer 200 k Ω (MN) (BALANCE)	☆ 3B
35	R08-5043-05	Potentiometer 100 k Ω (B) (VOLUME)	☆ 3B
36	S33-4024-05	Lever switch (DUBBING)	☆ 3B
37	S33-2054-05	Lever switch (TAPE MONITOR)	☆ 3B
38	S29-1121-05	Rotary-slide switch (SELECTOR)	☆ 3B
39	R06-4040-05	Potentiometer 50 k Ω (B) (MIC)	3B
40	E11-0070-05	Phone jack (MIC)	3B
41	S31-*	Slide switch (VOLTAGE SELECTOR)	☆ 2B

ADJUSTMENT/RÉGLAGES/ABGLEICH

POWER METER LEVEL ADJUSTMENT

1. Connect an AG set to 1 kHz and dummy load to Aux jack and speaker terminal respectively.
2. Connect an AC voltmeter across the dummy load.
3. Adjust the trimming pot VR3 (VR4), when the AC voltmeter indicating, $21\text{ V}/8\ \Omega$, for 50 W reading of power meter.

RÉGLAGE DU VU MÈTRE

1. Relier un AG (générateur de signaux audio) sur les prises Aux et une fausse charge (Resistance) sur les bornes de haut-parleur.
2. Relier un voltmètre aux deux extrémités de la résistance (ou aux borne de sortie + et -).
3. Régler le potentiomètre ajustable VR3 (VR4) en sorte que le VU mètre indique 50 W lorsque le voltmètre indique $21\text{ V}/8\ \Omega$.

PEGELEINSTELLUNG DES STROMMESSERS (POWER METER)

1. Einen AG (NF-Signalgenerator) an die AUX-Buchsen und eine künstliche Last ($8\ \Omega$, 100 W oder mehr) an die Lautsprecher-Anschlüsse anschließen.
2. Einen Wechselstrom-Voltmeter über die künstliche Last anschliessen.
3. Den AG auf 1 kHz einstellen.
4. Die Lautstärke regler (oder den AG-Ausgang) so einstellen, daß der Voltmeter 21 V anzeigt.
5. Das Trimm-Potentiometer VR3 (VR4) so einstellen, das der Strommesser 50 W anzeigt.

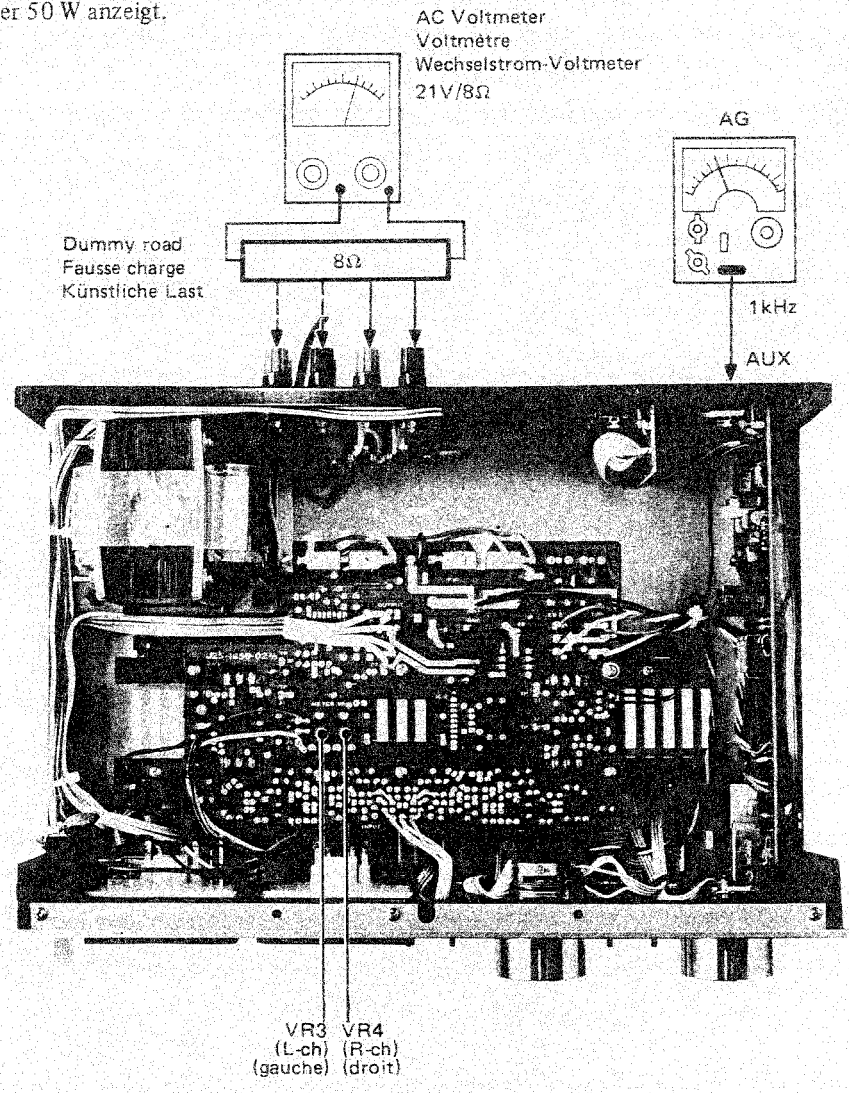

PC BOARD

▼POWER AMP PCB(X07-1720-10)
Foil Side View

Q1~4	: 2SA872(E)	IC1	: HA12002
Q5~8	: 2SA733A(Q,P)	IC2	: TA7318P
Q9,10,23,24	: 2SC945(Q,P)	D1,2,15,16	: WZ-140
Q11,12	: 2SC1775	D5,6	: STV-4H(G)
	or 2SC1845(E,U)	D7,8	: 1S2076
Q13,14	: 2SC1904(B,V)		or 1S1555
Q15,16	: 2SC1567(Q,R,S)	D9,10	: 1S2076A
Q17,18	: 2SA794(Q,R,S)	D11~14	: GP25D
Q19,20	: 2SC2580×1		or U05C(S)
Q21,22	: 2SA1105×1		

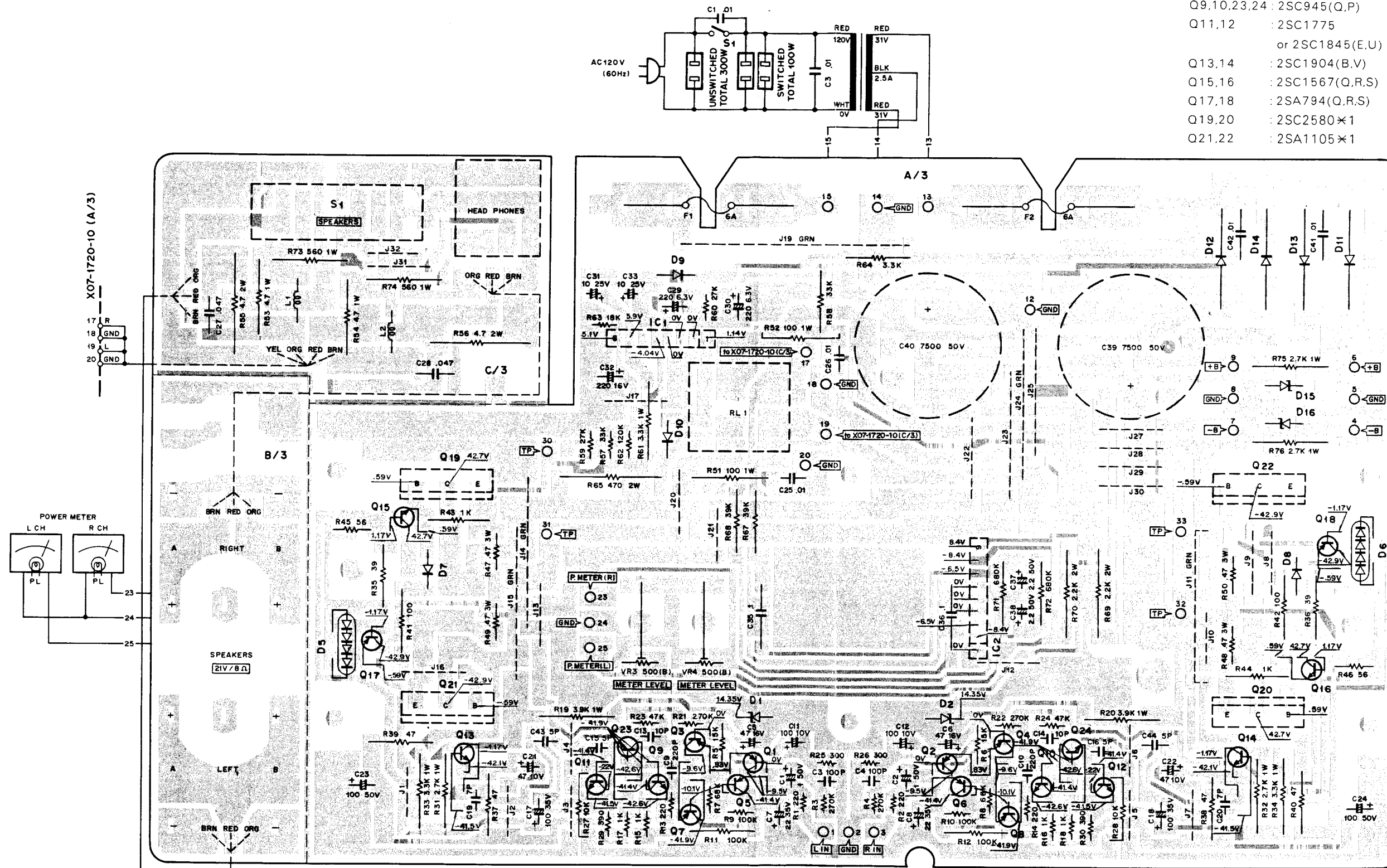

PC BOARD

▼POWER AMP PCB(X07-1720-10)
Foil Side View

Q1-4	2SA872(E)	IC1	HA12002
Q5-8	2SA733A(Q,P)	IC2	TA7318P
Q9,10,23,24	2SC945(Q,P)	D1,2,15,16	WZ-140
Q11,12	2SC1775 or 2SC1845(E,U)	D5,6	STV-4H(G)
Q13,14	2SC1904(S,V)	D7,8	1S2076 or 1S1555
Q15,16	2SC1567(Q,R,S)	D9,10	1S2076A
Q17,18	2SA794(Q,R,S)	D11-14	GP25D or U05C(S)
Q19,20	2SC2580×1		
Q21,22	2SA1105×1		

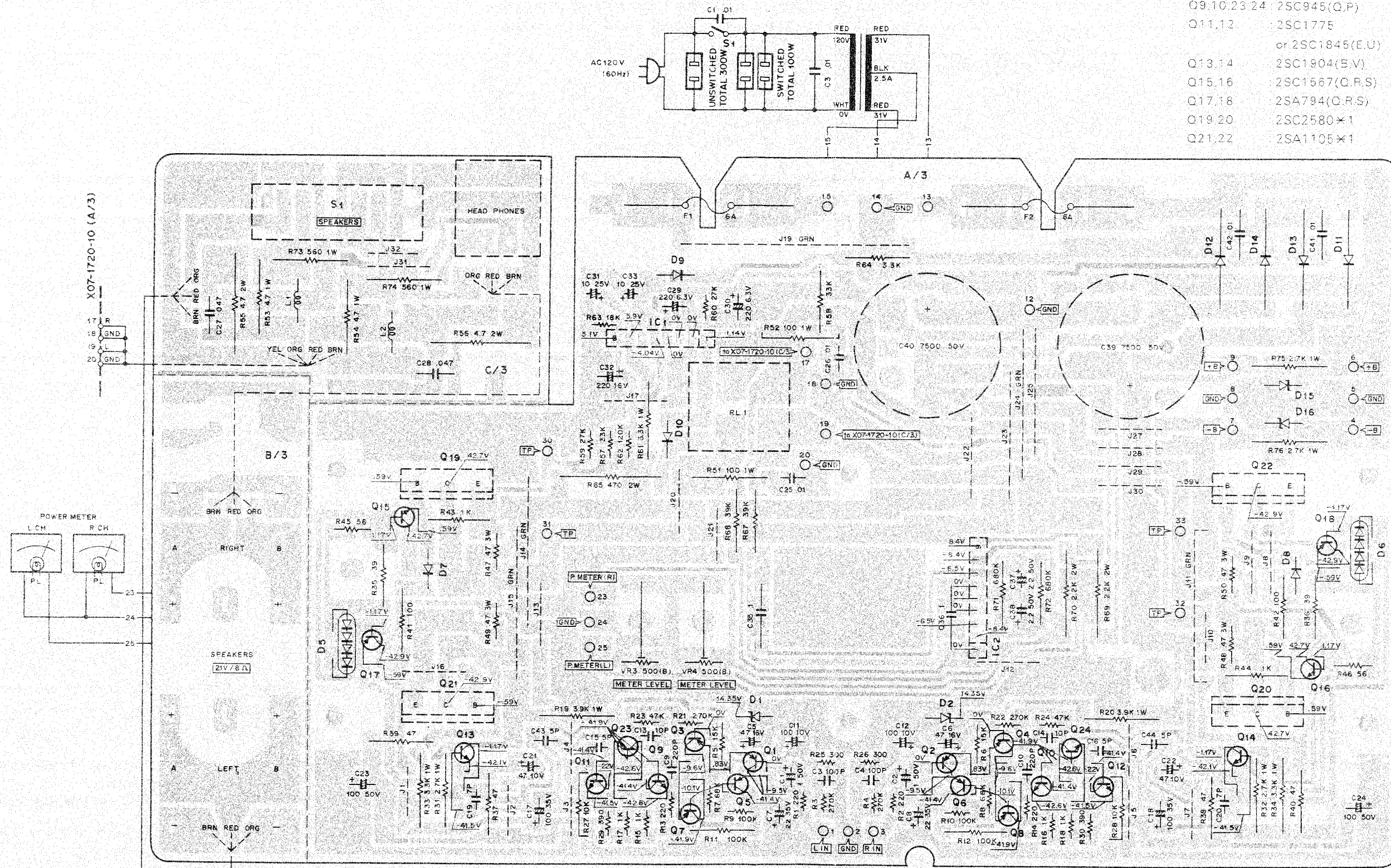

PC BOARD

▼PREAMP PCB (X08-1720-10) (A/4, D/4)
Foil Side View

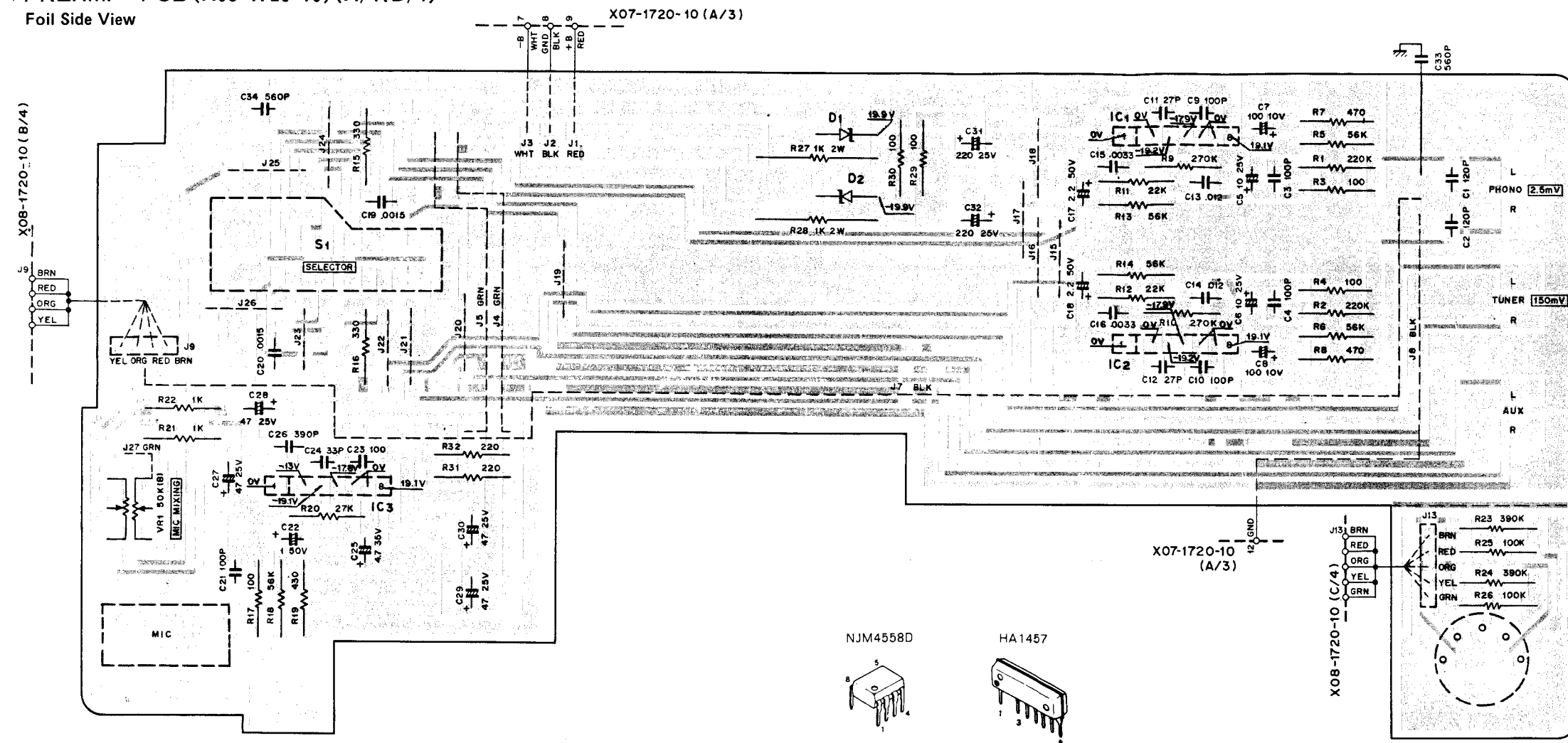

IC1~3:HA1457
D1,2:CZ-200

▼PREAMP PCB (X08-1720-10)
Components Side View (B/4, C/4)

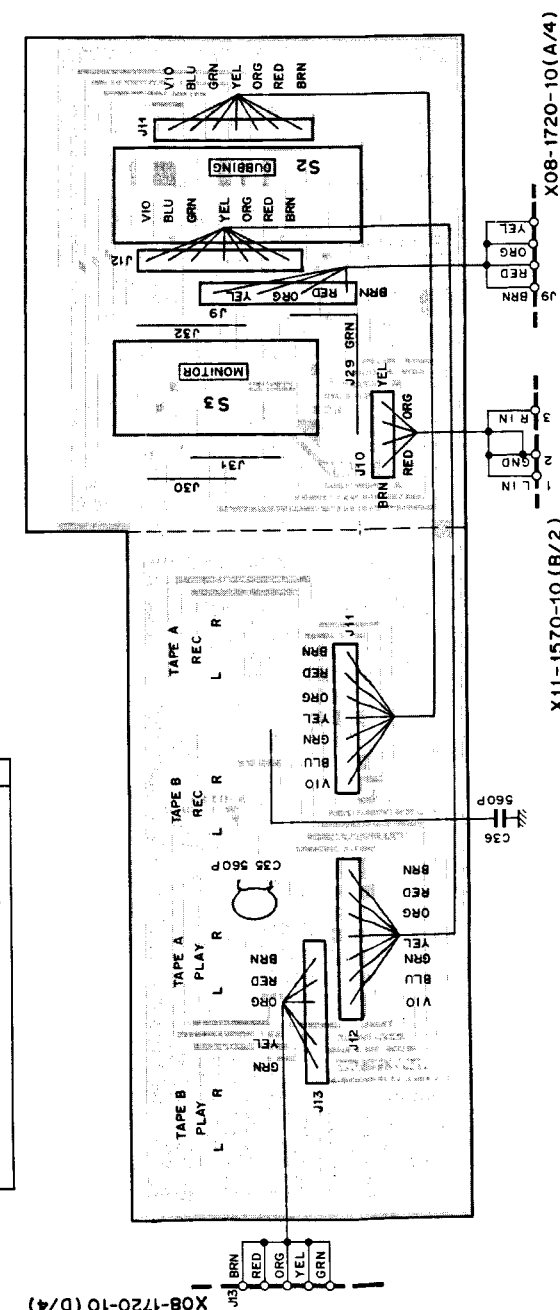

▼CONTROL PCB (X11-1570-10) Components Side View

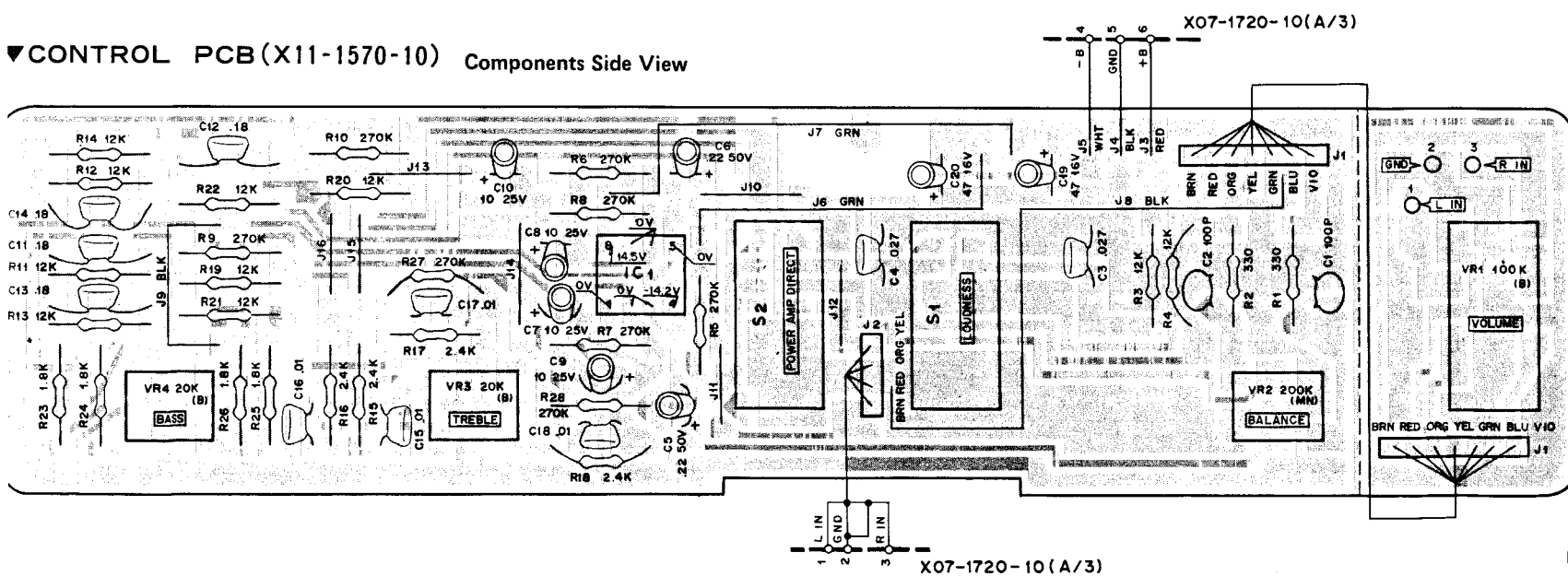

SEMICONDUCTOR SUBSTITUTIONS

SEMICONDUCTOR	SUBSTITUTIONS
X07- 2SA733A(Q,P)	2SA640, 2SA750, 2SA872
2SA794(Q,R,S)	2SA794A
2SA872(E)	2SA640, 2SA750
2SC2580×1	—
2SC945(Q,P)	2SC1222, 2SC1400, 2SC1775
2SC1567(Q,R,S)	2SC1567A
2SC1775	2SC1845(E,U)
2SC1904(B,V)	2SC1885
2SA1105×1	—
HA-12002	—
TA-7318P	—
X08-1720- HA-1457	—
X11-1570-10 NJM 4558D(A)	RC4558T(A), RC4559D(A) RC4559T(A)

IC1:NJM4558D(A)

PC BOARD

PREAMP PCB (X08-1720-10) (A/4, D/4)
Foils Side View

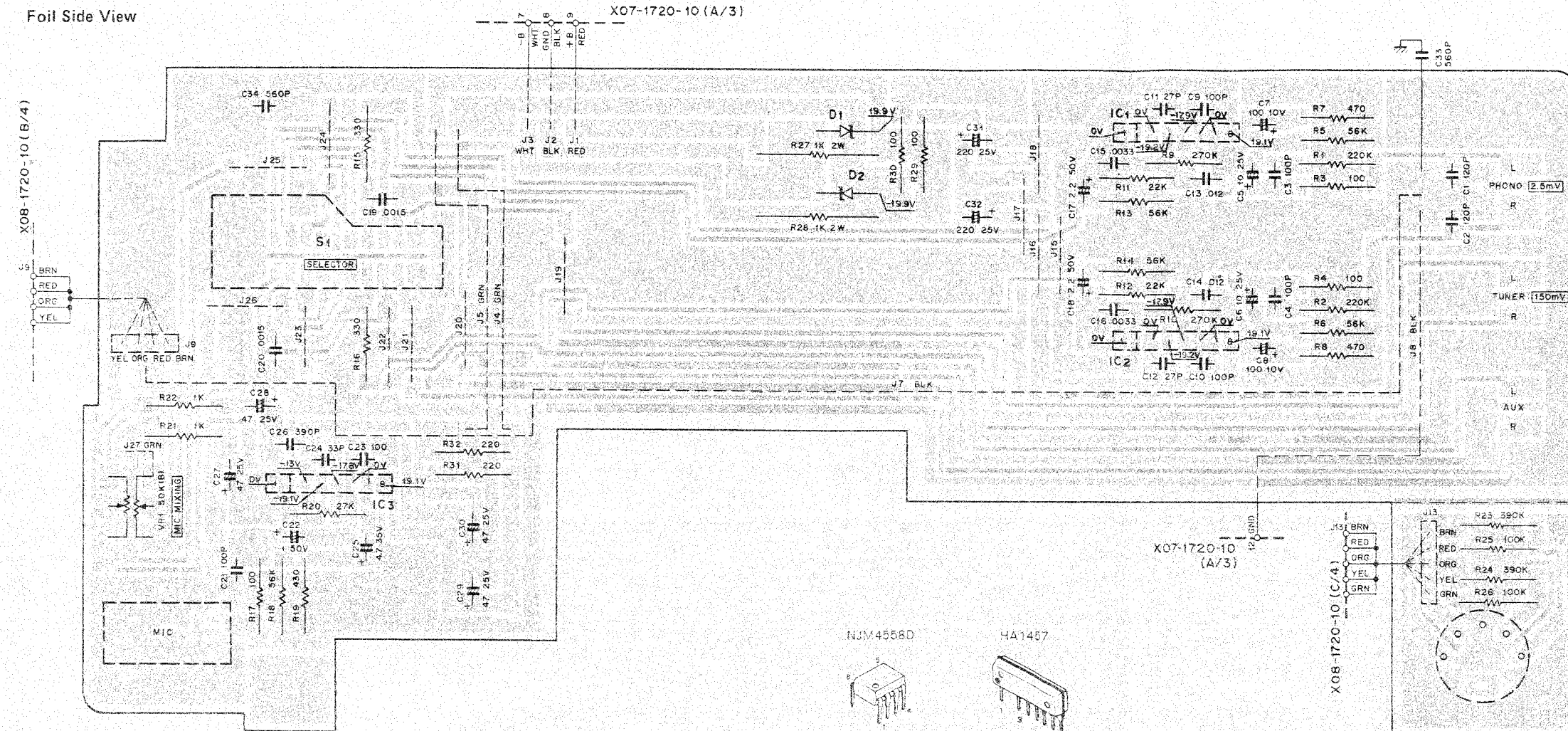

IC1-3 HA1457
D1,2 C2-200

PREAMP PCB (X08-1720-10)
Components Side View (B/4, C/4)

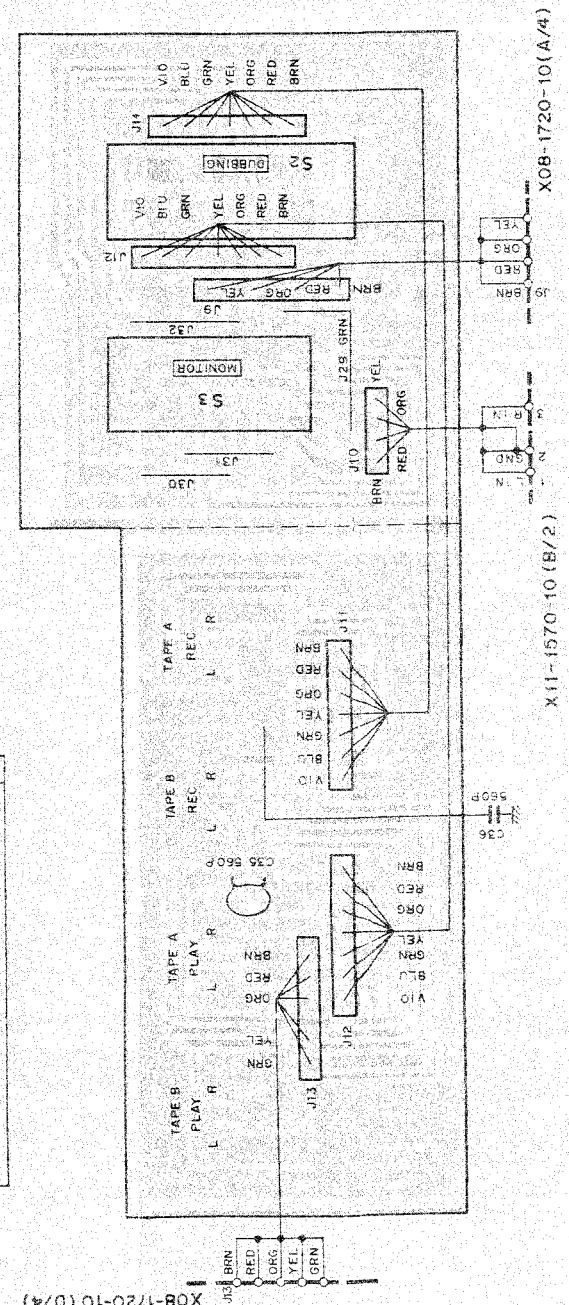

CONTROL PCB (X11-1570-10) Components Side View

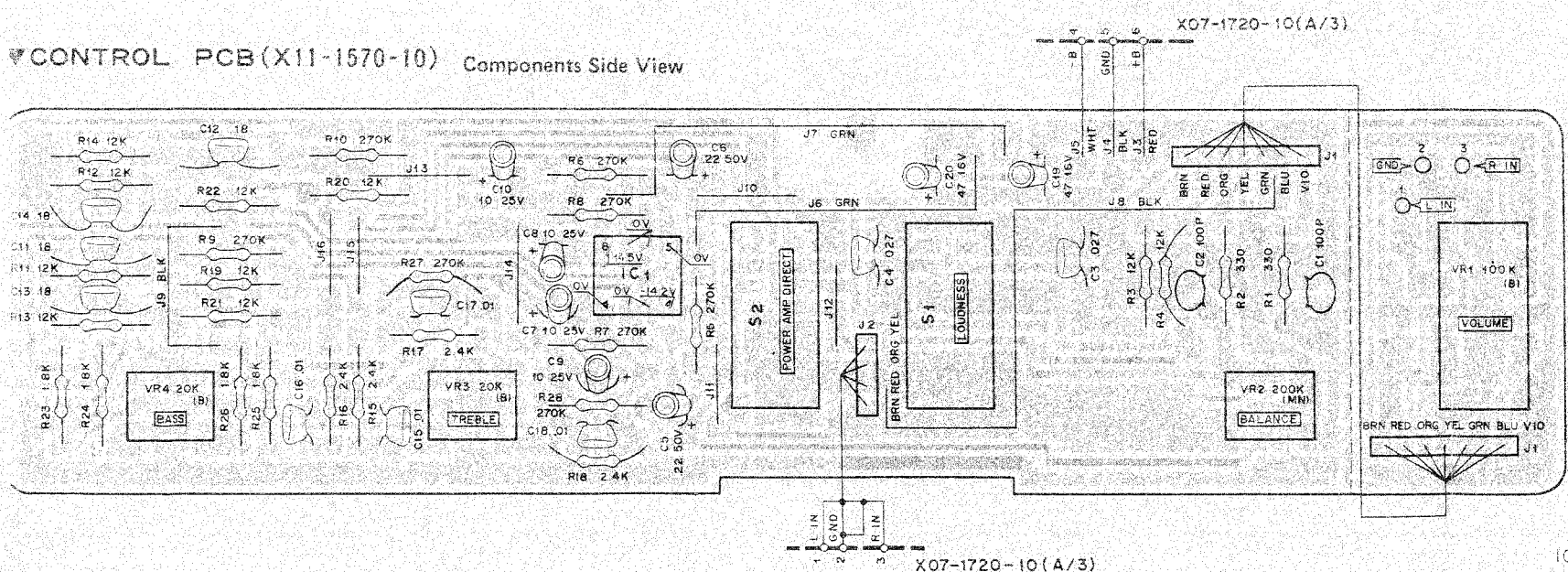

SEMICONDUCTOR SUBSTITUTIONS

SEMICONDUCTOR	SUBSTITUTIONS
X07-	
2SA733A(Q,P)	2SA640, 2SA750, 2SA872
2SA794(Q,R,S)	2SA794A
2SA872(E)	2SA640, 2SA750
2SC2580 × 1	-
2SC945(Q,P)	2SC1222, 2SC1400, 2SC1775
2SC1567(Q,R,S)	2SC1567A
2SC1775	2SC1845(E,U)
2SC1904(B,V)	2SC1885
2SA1105 × 1	-
HA-12002	-
TA-7318P	-
X08-1720-	
HA-1457	-
X11-1570-10	
NJM 4558D(A)	RC4558T(A), RC4559D(A), RC4559T(A)

IC1 NJM4558D(A)

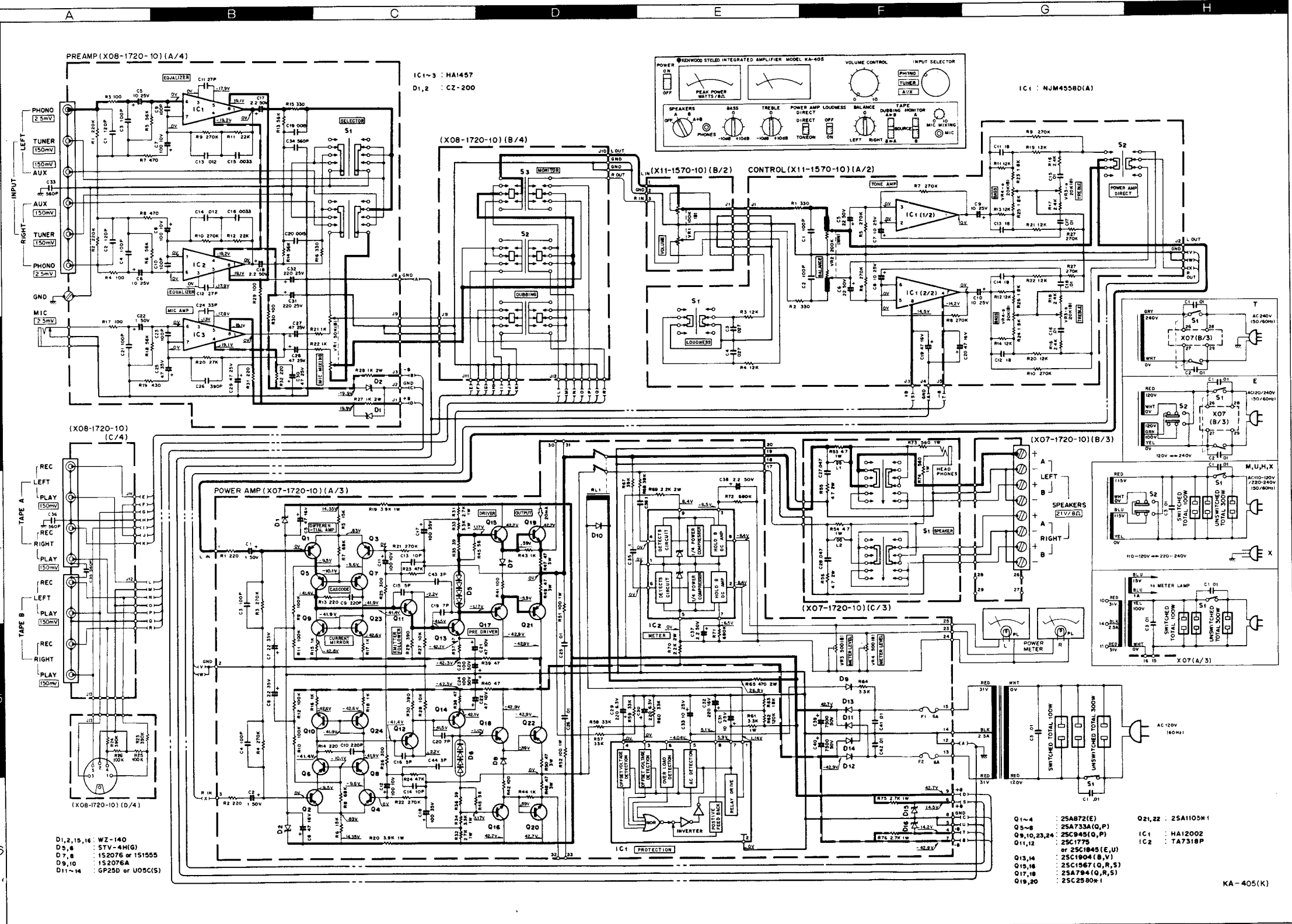
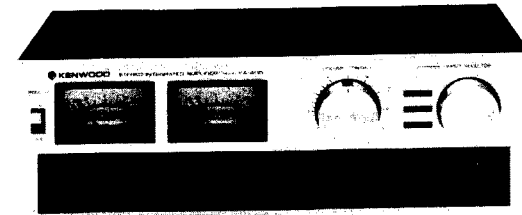

POWER OUTPUT
55 watts* per channel minimum RMS, both channels driven, at 8 ohms from 20 Hz to 20,000 Hz with no more than 0.05% total harmonic distortion.

Both Channels Driven	60 + 60 watts 8 ohms at 1,000 Hz 70 + 70 watts 4 ohms at 1,000 Hz
Total Harmonic Distortion	
AUX input to SPEAKER output (20 Hz - 20 kHz)	0.05% at rated power into 8 ohms
(1 kHz)	0.006% at rated power into 8 ohms
PHONO input to SPEAKER output (20 Hz - 20 kHz)	0.03% at 1/2 rated power into 8 ohms
(1 kHz)	0.05% at rated power with VOLUME - 20 dB
Intermodulation Distortion (60 Hz - 7 kHz = 4 : 1)	0.008% at rated power into 8 ohms
Damping Factor	45, 20 Hz - 20,000 Hz into 8 ohms
Transient Response	
Rise Time	1.4 μs
Slew Rate	± 70 V/μs
Power Bandwidth	5 Hz to 40,000 Hz at 0.05% T.H.D.
Frequency Response	2 Hz to 250 kHz, - 3 dB
Speaker Impedance	Accept 4 ohms to 16 ohms
Input Sensitivity/Impedance	
Phono	2.5 mV/50 kohms
Tuner	150 mV/30 kohms
AUX	150 mV/30 kohms
Tape	150 mV/30 kohms
Mic	2.5 mV/50 kohms
Signal-to-Noise Ratio (IHF, A)	
Phono	77 dB for 2.5 mV input 83 dB for 5.0 mV input 89 dB for 10 mV input
Tuner, AUX, Tape	105 dB for 150 mV input
Mic	73 dB for 2.5 mV input
Maximum Input Level for Phono	210 mV (RMS), T.H.D. 0.05% at 1,000 Hz
Output Level/Impedance	
Tape REC (Pin)	150 mV/220 ohms
(DIN)	30 mV/75 kohms
Frequency Response for Phono	RIAA standard curve ± 0.4 dB (30 Hz to 15,000 Hz)
Tone Control	
Bass	± 10 dB at 100 Hz
Treble	± 10 dB at 10,000 Hz
Loudness Control (at - 30 dB VOLUME Level)	+ 8 dB at 100 Hz
GENERAL	
Power Consumption	400 watts at full power
A.C. Outlet	Switched 2, Unswitched 1
Dimensions	W 400 mm (15-8/16") H 139 mm (5-11/32") D 296 mm (11-21/32")
Weight (Net)	7.6 kg (16.8 lbs)

Measured pursuant to Federal Trade Commission's Trade Regulation rule on Power Output Claims for Amplifier in U.S.A.

Note: Kenwood follows a policy of continuous advancements in development. For this reason specifications may be changed without notice.

- | | | | | | | | | | | | |
|---------|---------|---------|---------|----------|-----------|----------|---------|--------|---------|---------|---|
| 2SA640 | 2SA872 | 2SC1400 | 2SA794 | 2SC1567 | 2SA1105×1 | RC4559D | TA7318P | HA1457 | HA12002 | RC4558T | DC voltage measured with 20 kΩ/V VOM under no signal. |
| 2SA733A | 2SC0945 | 2SC1775 | 2SA794A | 2SC1567A | 2SC2580×1 | NJM4558D | | | | RC4559T | |
| 2SA750 | 2SC1222 | 2SC1845 | | 2SC1904 | | | | | | | |
| | 2SC1885 | | | | | | | | | | |

